

1. INSTRUCTIONS FOR USE	42
2. SAFETY PRECAUTIONS	44
3. ENVIRONMENTAL RESPONSIBILITY	46
4. GET TO KNOW YOUR OVEN.....	47
5. AVAILABLE ACCESSORIES	48
6. USING THE OVEN	51
7. COOKING WITH THE OVEN.....	56
8. CLEANING AND MAINTENANCE	64
9. EXTRAORDINARY MAINTENANCE	71
10. INSTALLING THE APPLIANCE	75



INSTRUCTIONS FOR THE USER: these instructions contain user recommendations, a description of the controls and the correct procedures for cleaning and maintenance of the appliance.



INSTRUCTIONS FOR THE INSTALLER: these are intended for the qualified technician who must install the appliance, set it functioning and carry out an inspection test.



1. INSTRUCTIONS FOR USE



THIS MANUAL IS AN INTEGRAL PART OF THE APPLIANCE. IT MUST BE KEPT IN ITS ENTIRETY AND IN AN ACCESSIBLE PLACE FOR THE WHOLE WORKING LIFE OF THE APPLIANCE.

CAREFUL READING OF THIS MANUAL AND ALL THE INSTRUCTIONS THEREIN BEFORE USING THE APPLIANCE IS ESSENTIAL. INSTALLATION MUST BE CARRIED OUT BY COMPETENT PERSONS IN ACCORDANCE WITH THE REGULATIONS IN FORCE. THIS APPLIANCE IS INTENDED FOR HOUSEHOLD USE AND COMPLIES WITH THE EEC DIRECTIVES CURRENTLY IN FORCE. THE APPLIANCE HAS BEEN BUILT TO CARRY OUT THE FOLLOWING FUNCTIONS: COOKING FOOD; ALL OTHER USES ARE CONSIDERED UNSUITABLE.

THE MANUFACTURER CANNOT BE HELD LIABLE FOR USE OTHER THAN AS INDICATED.



IF THE APPLIANCE IS INSTALLED ON BOATS OR IN CARAVANS, DO NOT USE IT AS A ROOM HEATER.



DO NOT USE THIS APPLIANCE FOR HEATING ROOMS.



THIS APPLIANCE IS MARKED ACCORDING TO EUROPEAN DIRECTIVE 2002/96/EC ON WASTE ELECTRICAL AND ELECTRONIC EQUIPMENT (WEEE).

THIS DIRECTIVE DEFINES THE STANDARDS FOR THE COLLECTION AND RECYCLING OF WASTE ELECTRICAL AND ELECTRONIC EQUIPMENT APPLICABLE THROUGHOUT THE EUROPEAN UNION.



NEVER OBSTRUCT THE OPENINGS AND SLITS PROVIDED FOR VENTILATION AND HEAT DISPERSAL.



DO NOT REST ANY WEIGHT OR SIT ON THE OPEN DOOR OF THE APPLIANCE.



THE IDENTIFICATION PLATE WITH THE TECHNICAL DATA, SERIAL NUMBER AND BRAND NAME HAS BEEN VISIBLY AFFIXED TO THE APPLIANCE.

DO NOT REMOVE THIS PLATE FOR ANY REASON.



BEFORE THE APPLIANCE IS PUT INTO OPERATION, ALL THE PROTECTIVE FILMS APPLIED INSIDE OR OUTSIDE MUST BE REMOVED.



TAKE CARE THAT NO OBJECTS ARE STUCK IN THE DOOR OF THE OVEN.



THE APPLIANCE BECOMES VERY HOT INSIDE DURING USE. SUITABLE HEAT-PROOF GLOVES SHOULD BE WORN FOR ALL OPERATIONS.



General instructions

GB-IE



DO NOT USE STEEL SPONGES AND SHARP SCRAPERS AS THEY WILL DAMAGE THE SURFACE.

USE NORMAL NON-ABRASIVE PRODUCTS, INCLUDING WOODEN OR PLASTIC UTENSILS IF NECESSARY. RINSE THOROUGHLY AND DRY USING A SOFT CLOTH OR A MICROFIBRE CLOTH.

DO NOT ALLOW RESIDUES OF SUGARY FOODS (SUCH AS JAM) TO SET INSIDE THE OVEN. IF THEY ARE ALLOWED TO SET FOR TOO LONG, THEY COULD RUIN THE ENAMEL COVERING THE INSIDE OF THE OVEN.



DO NOT USE PLASTIC KITCHENWARE OR CONTAINERS. THE HIGH TEMPERATURES INSIDE THE OVEN COULD MELT THE PLASTIC, DAMAGING THE APPLIANCE.



DO NOT USE SEALED TINS OR CONTAINERS IN THE APPLIANCE. OVERPRESSURE MAY OCCUR INSIDE THE CONTAINERS DURING COOKING, CREATING A DANGER OF EXPLOSION.



DO NOT LEAVE THE APPLIANCE UNATTENDED DURING COOKING PROCESSES WHERE FATS OR OILS COULD BE RELEASED. FATS AND OILS MAY CATCH FIRE.



DO NOT COVER THE BOTTOM OF THE OVEN WITH ALUMINIUM OR TINFOIL SHEETS DURING COOKING AND DO NOT PLACE PANS OR TRAYS ON IT TO AVOID DAMAGE TO THE ENAMELLED SURFACE.



IF THE SURFACES ARE STILL VERY HOT DURING COOKING, DO NOT POUR WATER DIRECTLY ONTO THE TRAYS. THE STEAM COULD CAUSE SEVERE BURNS AND DAMAGE TO ENAMELLED SURFACES.



ALL COOKING OPERATIONS MUST TAKE PLACE WITH THE DOOR CLOSED.



2. SAFETY PRECAUTIONS

REFER TO THE INSTALLATION INSTRUCTIONS FOR THE SAFETY REGULATIONS FOR ELECTRIC OR GAS APPLIANCES AND VENTILATION FUNCTIONS.

IN YOUR INTERESTS AND FOR YOUR SAFETY THE LAW REQUIRES THAT THE INSTALLATION AND SERVICING OF ALL ELECTRICAL APPLIANCES ARE CARRIED OUT BY QUALIFIED PERSONNEL IN ACCORDANCE WITH THE REGULATIONS IN FORCE.

OUR APPROVED INSTALLERS GUARANTEE A SATISFACTORY JOB.

GAS OR ELECTRICAL APPLIANCES MUST ALWAYS BE DISCONNECTED BY SUITABLY SKILLED PEOPLE.



BEFORE CONNECTING THE APPLIANCE TO THE POWER GRID, CHECK THE DATA ON THE PLATE AGAINST THE DATA FOR THE GRID ITSELF.



BEFORE CARRYING OUT INSTALLATION/MAINTENANCE WORK, MAKE SURE THAT THE APPLIANCE IS NOT CONNECTED TO THE POWER GRID.



THE PLUG TO BE CONNECTED TO THE POWER SUPPLY CABLE AND ITS SOCKET MUST BE OF THE SAME TYPE AND CONFORM TO THE REGULATIONS IN FORCE. THE SOCKET MUST BE ACCESSIBLE AFTER THE APPLIANCE HAS BEEN BUILT IN. NEVER DISCONNECT THE PLUG BY PULLING ON THE CABLE.



IF THE POWER SUPPLY CABLE IS DAMAGED, CONTACT THE TECHNICAL SUPPORT SERVICE IMMEDIATELY AND THEY WILL REPLACE IT.



IT IS OBLIGATORY FOR ALL ELECTRICAL EQUIPMENT TO BE EARTHED ACCORDING TO THE METHODS LAID DOWN BY SAFETY REGULATIONS.



IMMEDIATELY AFTER INSTALLATION, CARRY OUT A BRIEF INSPECTION TEST, FOLLOWING THE INSTRUCTIONS BELOW. SHOULD THE APPLIANCE NOT FUNCTION, DISCONNECT IT FROM THE ELECTRICITY SUPPLY AND CALL THE NEAREST TECHNICAL SUPPORT CENTRE. NEVER ATTEMPT TO REPAIR THE APPLIANCE.



NEVER PUT INFLAMMABLE OBJECTS IN THE OVEN: IF IT IS SWITCHED ON BY ACCIDENT, IT MAY CAUSE A FIRE.



DURING USE THE APPLIANCE BECOMES VERY HOT. TAKE CARE NOT TO TOUCH THE HEATING ELEMENTS INSIDE THE OVEN.



THIS APPLIANCE MAY NOT BE USED BY PEOPLE (INCLUDING CHILDREN) OF REDUCED PHYSICAL AND MENTAL CAPACITY, OR LACKING IN EXPERIENCE IN THE USE OF ELECTRICAL APPLIANCES, UNLESS THEY ARE SUPERVISED OR INSTRUCTED BY ADULTS RESPONSIBLE FOR THEIR SAFETY.



General instructions

GB-IE



DO NOT LET CHILDREN GO NEAR THE APPLIANCE WHEN IT IS IN OPERATION OR PLAY WITH IT AT ANY TIME.



DO NOT INSERT POINTED METAL OBJECTS (CUTLERY OR UTENSILS) INTO THE SLITS IN THE APPLIANCE.



DO NOT USE STEAM JETS FOR CLEANING THE APPLIANCE.
THE STEAM COULD REACH THE ELECTRONICS, DAMAGING THEM AND CAUSING SHORT-CIRCUITS.



DO NOT MODIFY THIS APPLIANCE.



DO NOT SPRAY ANY SPRAY PRODUCTS NEAR THE ELECTRICAL APPLIANCE WHILE IT IS IN OPERATION.
DO NOT USE SPRAY PRODUCTS WHILE THE PRODUCT IS STILL HOT.



The manufacturer cannot be held liable for damage to persons or things caused by failure to observe the above instructions, by interference with any part of the appliance or by the use of non-original spare parts.



3. ENVIRONMENTAL RESPONSIBILITY

3.1 Our environmental responsibility



Pursuant to Directives 2002/95/EC, 2002/96/EC and 2003/108/EC relating to the reduction of the use of hazardous substances in electrical and electronic appliances, as well as to the disposal of refuse, the crossed out bin symbol on the appliance indicates that at the end of the useful life of the product, it must be collected separately from other refuse. Therefore, the user must consign the product that has reached the end of its working life to the appropriate differentiated collection centres for electrical and electronic refuse, or deliver it back to the retailer when purchasing an equivalent product, on a one for one basis. Adequate differentiated collection for the subsequent forwarding of the decommissioned product to recycling, processing and ecologically compatible disposal contributes to avoiding possible negative effects on the environment and on health, and promotes recycling of the appliance's constituent materials. Illicit disposal of the product by the user will lead to the application of administrative sanctions.

The product does not contain substances in quantities sufficient to be considered hazardous to health and the environment, in accordance with current European directives.

3.2 Your environmental responsibility

Our product's packing is made of non-polluting materials, which are therefore compatible with the environment and recyclable. Please help by disposing of the packing correctly. You can obtain the addresses of collection, recycling and disposal centres from your retailer or from the competent local organisations.



Do not discard the packaging or any part of it, or leave it unattended. It can constitute a suffocation hazard for children, especially the plastic bags.

Your old appliance also needs to be disposed of correctly.

Important: hand over your appliance to the local agency authorised for the collection of electrical appliances no longer in use. Correct disposal enables intelligent recovery of valuable materials.

Before disposing of your appliance it is important to remove doors and leave shelves in the same position as for use, to ensure that children cannot accidentally become trapped inside during play. It is also necessary to cut the connecting cable to the power supply network, removing it along with the plug.



4. GET TO KNOW YOUR OVEN

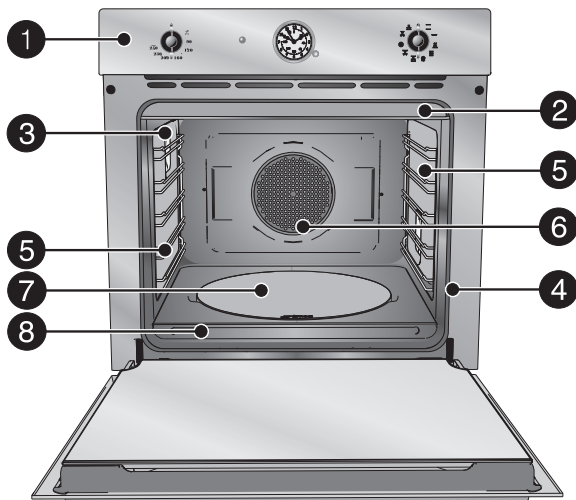

- 1** Control panel
- 2** Roof liner
- 3** Oven light
- 4** Oven seal
- 5** Rack and tray support frames (on some models only)
- 6** Oven fan
- 7** Pizza plate or cover recess (on some models only)
- 8** Bottom plate (on some models only)



5. AVAILABLE ACCESSORIES

NOTE:

Some models are not provided with all accessories.

Rack: for holding cooking containers.

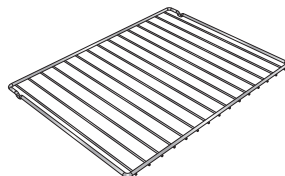

Tray rack: to be placed over the top of the oven tray; for cooking foods which may drip.



Oven tray: for collecting fat from foods placed on the rack above.



Pizza plate: specially designed for cooking pizza and similar dishes.

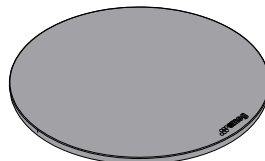

Pizza spatula: for easy placement of the pizza on the pizza plate.

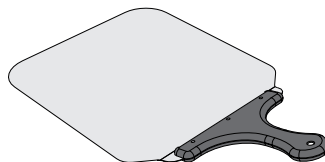

Pizza plate cover: for covering the pizza plate when it is not in use.

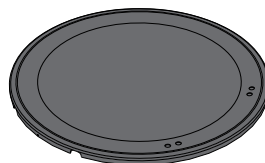

- Accessories available on request: Original supplied and optional accessories may be ordered from any Authorised Support Centre.
- Use original accessories only.



5.1 Using the rack or tray

The racks and trays are equipped with a mechanical safety lock which prevents them from being taken out accidentally. To insert the rack or tray correctly, check that the lock is facing downwards (as shown in the figure at the side).

To remove the rack or tray, lift the front slightly.

The mechanical lock must always face the back of the oven.

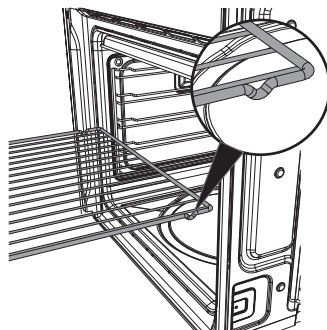

Insert racks and trays fully into the oven until they come to a stop.

5.2 Using the support rack

The support rack is inserted into the tray (as shown in the figure).

Using this, foods can be cooked and the fat can be collected separately from the food which is being cooked.





5.3 Using the pizza plate (on some models only)

With the oven cold, remove the circular cover from the bottom (as shown in the figure) and insert the pizza plate.

Make sure that the plate is inserted correctly in the recess provided.

For cooking use the special pizza

function .

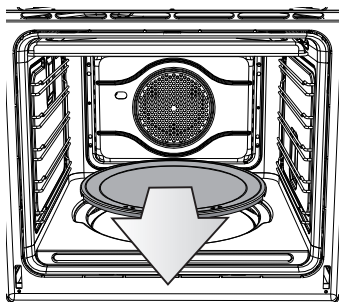

Do not use the pizza plate other than as described, for example do not use it on gas or glass ceramic hobs or in ovens which are not designed for this purpose.



If you wish to add oil to your pizza, it is best to add it after removing it from the oven since oil stains on the pizza plate are unsightly and may reduce its efficiency.



In models where it is provided, if the pizza plate is not in use, cover the bottom of the oven with the cover provided.

5.4 Using the pizza spatula (on some models only)

Always grip the pizza spatula on the wooden handle to put food in and take it out of the oven.

You are advised to dust the steel surface **lightly** with flour to make it easier to slide fresh products on and off, as they could stick to the steel due to their moisture content.

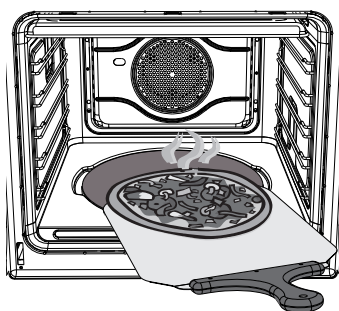



6. USING THE OVEN

6.1 Before using the appliance



- Remove any labels (apart from the technical data plate) from trays, dripping pans and the cooking compartment.
- Remove any protective film from the outside or inside of the appliance, including from accessories such as trays, dripping pans, the pizza plate or the base cover.
- Before using the appliance for the first time, remove all accessories from the oven compartment and wash them as indicated in "8. CLEANING AND MAINTENANCE".



Heat the empty appliance to the maximum temperature in order to remove any manufacturing residues which could affect the food with unpleasant odours.

6.2 General Description

6.2.1 Oven runners

The oven features **5 runners** for positioning trays and racks at different heights. The insertion heights are numbered from the bottom upwards (see figure). (When using the recipes, the display will show the recommended runner for the selected recipe.)

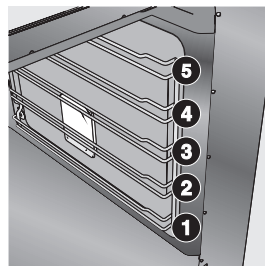

6.2.2 Cooling system

The appliance is equipped with a cooling system which comes into operation as soon as a cooking function starts. The fan causes a steady outflow of air from above the door which may continue for a brief period of time even after the oven has been turned off.

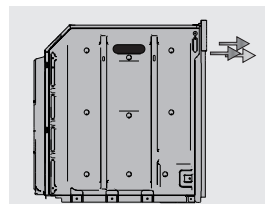

6.2.3 Oven inside lights

The oven lights come on when the door is opened (depending on model) or any function is selected.



6.3 Warnings and general advice for usage



All cooking operations must be carried out with the door closed.



During cooking, do not cover the bottom of the oven with aluminium or tin foil and do not place pans or oven trays on it as this may damage the enamel coating. If you wish to use greaseproof paper, place it so that it will not interfere with the hot air circulation inside the oven.



For the best cooking results, we recommend placing cookware in the centre of the rack.

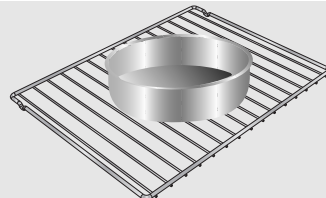

To prevent any steam in the oven from causing problems, open the door in two stages: half open (5 cm approx.) for 4-5 seconds and then fully open. If you need to access the food, always leave the door open for as short a time as possible to prevent the temperature in the oven from falling and ruining the food.

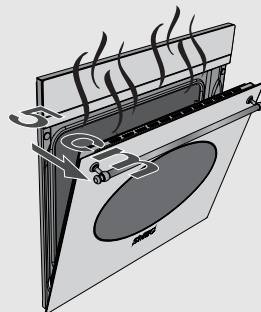

To prevent excessive amounts of condensation from forming on the internal glass, hot food should not be left inside the oven for too long after cooking.



6.4 Description of the controls on the front panel

All the appliance's control and monitoring devices are located together on the front panel.

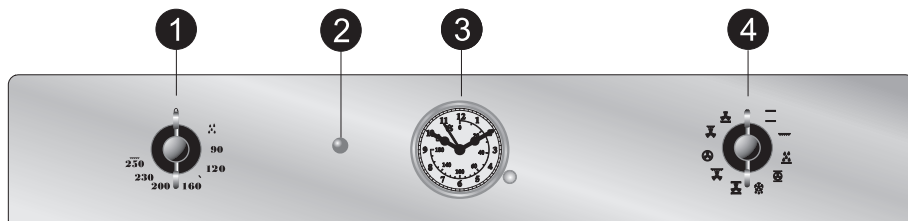

OVEN THERMOSTAT KNOB

- 1 This knob can be used to select the cooking temperature. Turn the knob clockwise to the desired value, between 50°C and 250°C.

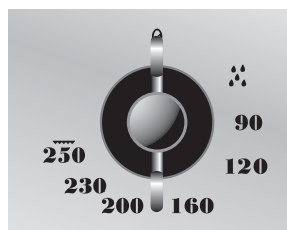

THERMOSTAT LIGHT (on some models only)

- 2 When this is flashing, it indicates that the oven is heating up to the temperature set using the thermostat knob. Once the oven has reached the selected temperature:
When the light flashes regularly, it means that the temperature inside the oven is kept steady on the set level.





PROGRAMMING CLOCK

3

The programming clock can be used to display the current time or to set a timer (only on multifunction models) or cooking programme (only for pyrolytic models).

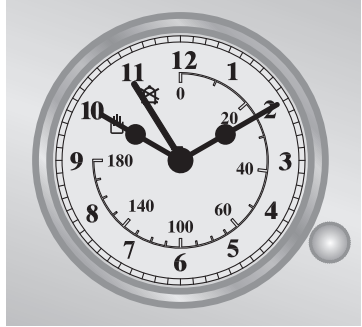
**4**

FUNCTION KNOB

Turn the knob clockwise or anti-clockwise to select a function (some functions are not present on all models) from the following options: (See 7. COOKING WITH THE OVEN).





6.5 Programming clock

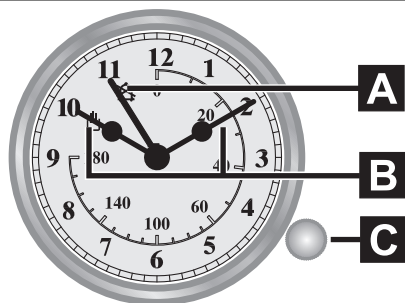

- A** Manual or timed cooking pointer
- B** Hour - minute pointers
- C** Adjustment knob

The programmer enables manual cooking or the timer to be selected, or the cooking time to be set.



Select the desired function and cooking temperature before setting the cooking time.

6.5.1 Setting the time

To set the correct time, pull out and rotate the knob **C** clockwise.

6.5.2 Manual cooking

To use the oven with manual cooking, turn knob **C** clockwise until the **A** pointer is aligned with the symbol .

6.5.3 Timed cooking

To set the cooking time, turn knob **C** clockwise until the **A** pointer is aligned with the required time (maximum 180 minutes).

6.5.4 End of cooking

The oven will switch off automatically and simultaneously a buzzer will start to sound.

6.5.5 Stopping the buzzer

To switch off the buzzer, turn knob **C** clockwise until the **A** pointer is aligned with the symbol .

The programmer enables manual cooking or the timer to be selected, or the cooking time to be set.



Select the desired function and cooking temperature before setting the cooking time.



7. COOKING WITH THE OVEN

ECO: (on some models only)

ECO

Using the grill and the lower heating element in combination is particularly suitable for cooking on a single runner only, as it provides low energy consumption.



STATIC:



As the heat comes from above and below at the same time, this system is particularly suitable for certain types of food. Traditional cooking, also known as static or thermal radiation cooking, is suitable for cooking just one dish at a time. Perfect for all types of roasts, bread and cakes and in any case particularly suitable for fatty meats such as goose and duck.

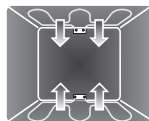

GRILL:



The heat coming from the grill element gives perfect grilling results, especially for thin and medium thickness meat and, in combination with the rotisserie (when present), it allows the food to be browned evenly at the end of cooking. Perfect for sausages, ribs and bacon. This function enables large quantities of food, particularly meat, to be grilled evenly. (4rd or 5th runner).

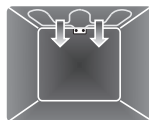

FAN-ASSISTED BOTTOM:



The combination of the fan with just the lower heating element allows cooking to be completed more rapidly. This system is recommended for sterilising or for finishing off the cooking of foods which are already well-cooked on the surface, but not inside, which therefore need a little more heat. Perfect for any type of food.



BOTTOM:



The heat coming solely from the bottom makes it possible to complete the cooking of foods that require a greater basic temperature, without affecting their browning. Perfect for cakes, pies, tarts and pizzas.

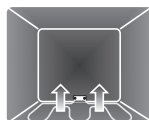

FAN-ASSISTED STATIC:



The operation of the fan, combined with traditional cooking, ensures uniform cooking even with complex recipes. Perfect for biscuits and cakes, even when simultaneously cooked on several levels. (For multiple-level cooking, you are advised to use the 2st and 4rd runners.)





FAN-ASSISTED GRILL:



The air produced by the fan softens the strong heatwave generated by the grill, giving perfect grilling results even with very thick foods. Perfect for large cuts of meat (e.g. shin of pork). We recommend using the 4rd runner.

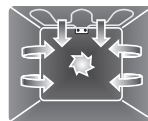

CIRCULAR:



The combination of the fan and the circular element (incorporated in the rear of the oven) enables different foods to be cooked on several levels, as long as they need the same temperature and cooking time. Hot air circulation ensures instant and uniform distribution of heat. It will be possible, for instance, to cook fish, vegetables and biscuits simultaneously (on different levels) without mixing smells and flavours.

(For multiple-level cooking, you are advised to use the 2st and 4rd runners.)

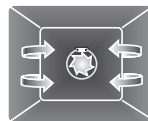

TURBO:



The combination of fan-assisted cooking and traditional cooking enables different foods to be cooked on several levels extremely quickly and efficiently, without any transfer of smells and flavours.

Perfect for large volumes that call for intense cooking.

(For multiple-level cooking, you are advised to use the 2st and 4rd runners.)



DEFROSTING:



The movement of air caused by the fan makes food defrost faster. The air circulating inside the oven is at room temperature.

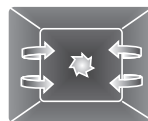

PIZZA: (on some models only)



The operation of the fan, combined with the grill and the lower heating element, ensures uniform cooking even with complex recipes. Perfect not just for pizzas, but also for biscuits and cakes.







7.1 Cooking advice and instructions

7.1.1 General advice

We recommend preheating the oven before putting the food in.

For cooking on several levels, we recommend using a fan-assisted function

( ,  , ) to achieve uniform cooking at all heights.

In general, it is not possible to shorten the cooking times by increasing the temperature (the food could be well-cooked on the outside and undercooked on the inside).

7.1.2 Advice for cooking meat

Cooking times, especially for meat, vary according to the thickness and quality of the food and to consumer taste.

We recommend using a meat thermometer for meat when roasting it. Alternatively, simply press on the roast with a spoon: if it is hard, it is ready; if not, it needs another few minutes cooking.

7.1.3 Advice for cooking desserts and biscuits

Use dark metal moulds for desserts: they help to absorb the heat better.

The temperature and the cooking duration depend on the quality and consistency of the dough.

Check whether the dessert is cooked all the way through: at the end of the cooking time, put a toothpick into the highest point of the dessert. If the dough does not stick to the toothpick, the dessert is cooked.

If the dessert collapses when it comes out of the oven, on the next occasion reduce the set temperature by about 10°C, selecting a longer cooking time if necessary.



7.1.4 Advice for defrosting and proving

We recommend positioning frozen foods in a lidless container on the first runner of the oven.

The food must be defrosted without its wrapping.

Lay out the foodstuffs to be defrosted evenly, not overlapping.

When defrosting meat, we recommend using a rack positioned on the second runner with the food on it and a tray positioned on the first runner. In this way, the liquid from the defrosting food drains away from the food.

The most delicate parts can be covered with aluminium foil.

For successful proving, a container of water should be placed in the bottom of the oven.

7.1.5 Advice for cooking with the Grill and the Fan-assisted grill

Using the Grill function , meat can be grilled even when it is put into the oven cold; preheating is recommended if you wish to change the effect of the cooking.

With the Fan-assisted grill function , however, we recommend that you preheat the oven before grilling.

We recommend placing the food at the centre of the rack.

7.2 To save energy

To save energy during use of the appliance, the following instructions may be followed:

- Stop cooking a few minutes before the time normally used. Cooking will continue for the remaining minutes with the heat which has accumulated inside the oven.
- Reduce any opening of the door to a minimum to avoid heat dispersal.
- Use the ECO function (if fitted) for cooking on a single runner.
- Keep the inside of the appliance clean at all times.

























7.3 Cooking process information table

DISHES	WEIGHT	FUNCTION
FIRST COURSES		
LASAGNE	3 kg	Static
OVEN-BAKED PASTA		Static
MEAT		
ROAST VEAL	1 kg	Fan-assisted static
LOIN OF PORK	1 kg	Fan-assisted static
SHOULDER OF PORK	1 kg	Turbo / Circular
ROAST RABBIT	1 kg	Circular
TURKEY BREAST	1 kg	Fan-assisted static
ROAST NECK OF PORK	1 kg	Turbo
ROAST CHICKEN	1 kg	Turbo
GRILLED MEATS		
PORK CHOPS		Fan-assisted grill
FILLET OF PORK		Grill
FILLET OF BEEF		Grill
LIVER		Fan-assisted grill
SAUSAGES		Fan-assisted grill
MEAT BALLS		Grill
ROTISSERIE MEATS		
CHICKEN		Rotisserie grill
FISH		
SALMON TROUT	0.7 kg	Fan-assisted static



RUNNER POSITION FROM BOTTOM	TEMPERATURE °C	TIME IN MINUTES	
2 or 3	220 - 230	40 - 50	
2 or 3	220 - 230	40	
3	180 - 190	70 - 80	
3	180 - 190	70 - 80	
3	180 - 190	90 - 100	
3	180 - 190	70 - 80	
3	180 - 190	110 - 120	
3	180 - 190	110 - 120	
3	190 - 200	60 - 70	
		1 ST SURFACE	2 ND SURFACE
5	250 - 280	7 - 9	5 - 7
4	250 - 280	9 - 11	5 - 9
4	250 - 280	9 - 11	9 - 11
5	250 - 280	2 - 3	2 - 3
4	250 - 280	7 - 9	5 - 6
4	250 - 280	7 - 9	5 - 6
On a rotisserie rod	250 - 280	60 - 70	
3	160 - 170	35 - 40	



DISHES	WEIGHT	FUNCTION
PIZZA		 Fan-assisted static
PIZZA (on pizza plate)		 Pizza
BREAD		 Circular
FOCACCIA		 Turbo / Circular
DESSERTS		
DOUGHNUT		 Fan-assisted static
FRUIT TART		 Fan-assisted static
FRUIT TART		 Static
SHORT PASTRY		 Circular
JAM TARTS		 Turbo / Circular
PARADISE CAKE		 Fan-assisted static
PARADISE CAKE		 Static
ECLAIR		 Turbo / Circular
LIGHT SPONGE CAKE		 Circular
RICE PUDDING		 Turbo / Circular
RICE PUDDING		 Static
CROISSANTS		 Circular
APPLE PIE		 Static
CROISSANTS (on multiple runners)		  
SHORT PASTRY BISCUITS (on multiple runners)		  

The times indicated in the following tables do not include the preheating times and are provided as a guide only.



RUNNER POSITION FROM BOTTOM	TEMPERATURE °C	TIME IN MINUTES
2	280	8
pizza plate	280	4
3	190 - 200	30 -35
3	180 - 190	15 -20
3	160 - 170	50 - 55
3	160 - 170	30 - 35
3	170	35 - 40
3	160 - 170	20 - 25
3	170	20 - 25
3	160 - 170	50 - 60
3	170	50 - 60
3	150 - 160	40 - 50
3	150 - 160	45 - 50
3	160	40 - 50
3	170	50 - 60
3	160	25 - 30
4	180	60
2 and 4	160 - 170	16 - 20
2 and 4	160 - 170	16 - 20



For cooking on multiple runners, we recommend that you use functions



only, and the 2st and 4rd runners.



8. CLEANING AND MAINTENANCE



NEVER USE A STEAM JET FOR CLEANING THE APPLIANCE.



We recommend the use of cleaning products distributed by SMEG.

8.1 Cleaning stainless steel

To keep stainless steel in good condition it should be cleaned regularly after use. Let it cool first.

8.2 Ordinary daily cleaning

To clean and preserve the stainless steel surfaces, always use **only** specific products that do not contain abrasives or chlorine-based acids.

How to use: pour the product onto a damp cloth and wipe the surface, rinse thoroughly and dry with a soft cloth or a microfibre cloth.

8.3 Food stains or residues

Do not use steel sponges or sharp scrapers as they will damage the surface.

Use normal non-abrasive products and a wooden or plastic tool if necessary. Rinse thoroughly and dry with a soft cloth or a microfibre cloth.



Do not allow residues of sugary foods (such as jam) to set inside the oven. If left to set for too long, they might damage the enamel lining of the oven.



8.4 Cleaning the door glazing

The glass in the door should always be kept thoroughly clean. Use absorbent kitchen roll; remove stubborn dirt with a damp sponge and an ordinary detergent.



Do not use abrasive or corrosive cleaners for cleaning the door glazing. (e.g. powder products, oven-cleaner sprays, stain removers and metal scouring pads).

Do not use rough or abrasive materials or sharp metal scrapers to clean the oven's glass doors since they may scratch the surface.



8.5 Cleaning the inside of the oven

For the best oven upkeep, clean it regularly after having allowed it to cool.

- Take out all removable parts.
- Clean the oven racks with hot water and non-abrasive detergent. Rinse and dry.
- For easier cleaning, the door can be removed (see “9.2 Removing the door”).

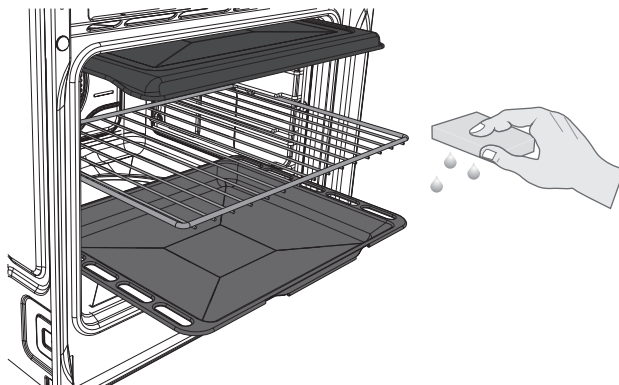

The oven should be operated at the maximum temperature for about 15-20 minutes after the use of specific products, to burn off the residues left inside the oven.

On pizza models only, to clean the bottom of the oven, the following operations have to be carried out first:

Remove the cover then the base on which it is resting. The base must be lifted a few millimetres, then pulled outwards.

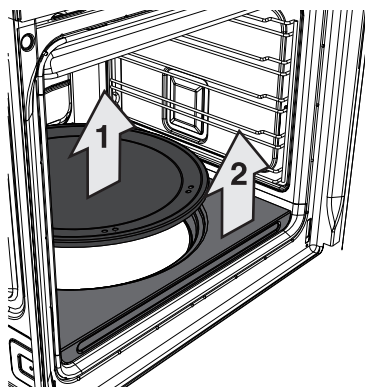



Lift up the edge of the lower heating element a few centimetres and clean the bottom.

Put the pizza plate support back in place, pushing it in until it hits the back of the oven, and push it down so that the heating element plate is embedded into the base itself.

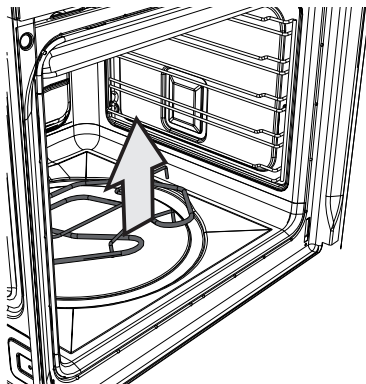

When the operation is complete, damp parts should be dried thoroughly.

8.5.1 Removing guide frames

Removing the guide frames makes it easier to clean the side parts, and it also needs to be done whenever the automatic cleaning cycle is used (only available on some models).

- To remove the guide frames, pull the frame towards the inside of the oven to unhook it from its housing **A**, then slide it out of the seats at the back **B**.
- When cleaning is complete, repeat the above procedures to put the guide frames back in.

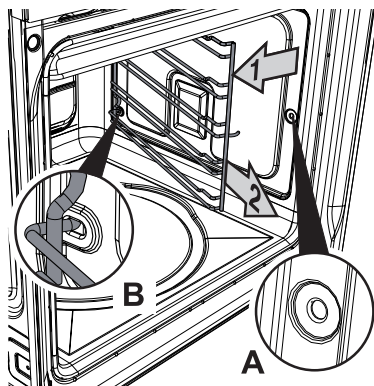



8.6 Cleaning the pizza plate

The pizza plate (where included) should be washed separately according to the following instructions:

Multifunction models: the stone must be cleaned after every use. Do not heat it again if it has any encrustations.

To clean, pour 55 cc of vinegar onto the stone, leave it to act for 10 minutes, then remove it by wiping with a metallic mesh or abrasive sponge.

Rinse with water then leave to dry.

- Before cleaning, remove any dirt burnt onto the stone with the aid of a metal spatula or a scraper of the kind used for cleaning glass ceramic hobs.
- For best results, the stone must still be warm; otherwise, wash it in hot water.
- Use metal mesh sponges or abrasive scotch-brite pads, dipped in lemon or vinegar.
- Never use detergents.
- Never wash in the dishwasher.
- Never leave the stone to soak.
- The damp stone must not be used for at least 8 hours after the end of the cleaning procedures.
- Over time, slight cracks may appear on the surface of the stone. This is due to the normal expansion of the stone's finishing glazes at high temperatures.



8.7 VAPOR CLEAN: assisted oven cleaning



VAPOR CLEAN is an assisted cleaning procedure which facilitates the removal of grease and oily residues. Thanks to this process, it is possible to clean the inside of the oven very easily. The dirt residues are softened by the heat and water vapour for easier removal afterwards.



Before starting the assisted cleaning cycle, make sure that the oven does not contain any foods or large spills from previous cooking operations.



Carry out assisted oven cleaning operations only when the oven is cold.

8.7.1 Before starting the assisted cleaning cycle

- Completely remove all accessories from inside the oven. The roof lining can be left inside the oven.

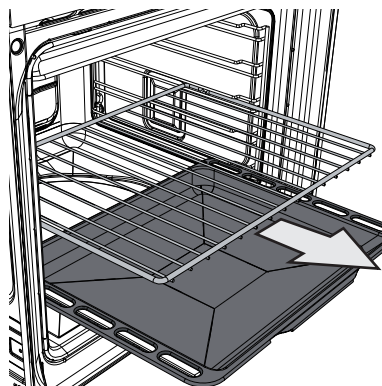

IN MULTIFUNCTION MODELS

- Pour approx. 40 cl (equivalent to about two glasses) of water onto the floor of the oven (as shown in the figure). Make sure it does not overflow out of the cavity.

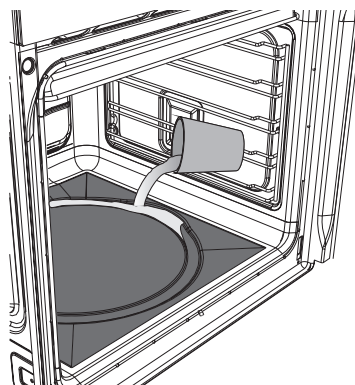



IN PIZZA MODELS

- Place a tray on the base of the oven as shown in the figure;
- Pour approximately 40 cl of water into the tray. Make sure it does not overflow out of the cavity.

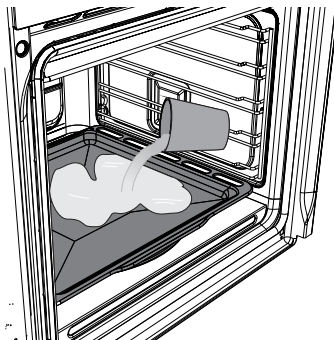

- Spray a water and washing up liquid solution inside the oven using a spray nozzle. Aim the spray towards the side walls, roof, floor and deflector (the coloured zone on the figure to the side shows where the solution can be sprayed).

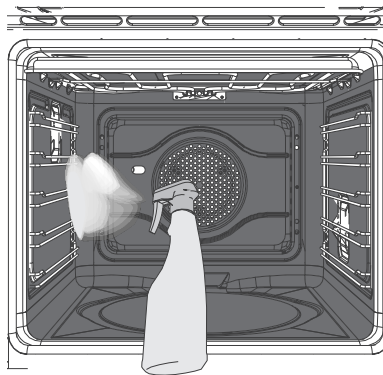

Do not spray excessive amounts of the water and washing up liquid solution. We recommend spraying approx. 20 times at the most.

- Close the door and set the assisted cleaning cycle.
- During the assisted cleaning cycle, wash the self-cleaning panels which were previously removed separately with warm water and a small amount of detergent.





8.7.2 Setting the assisted cleaning cycle



The assisted cleaning cycle can only be activated when the oven is cold.

Once the preparations have been made for the assisted cleaning cycle, proceed as follows:

- turn the oven function knob to the symbol  and the oven thermostat knob to the symbol  for the Vapor Clean function;
 - set a cooking time of 15 minutes using the timer control knob;
- At the end of the assisted cleaning cycle, the timer will deactivate the oven heating elements.

8.7.3 End of the assisted cleaning cycle



The water remaining at the end of the assisted cleaning cycle cannot be left inside the oven for long (for example overnight).



You are advised to wear a pair of gloves during these processes.



Do not use abrasive sponges on the deflector or self-cleaning panels.

At the end of the cleaning cycle:

- open the door and wipe away the less stubborn dirt with a microfibre cloth. Use an anti-scratch sponge with brass filaments on more difficult encrustations (we recommend removing the door to facilitate access to restricted spaces);
- dry the oven with a microfibre cloth;
- reposition the self-cleaning panels and the oven runners.

For improved hygiene and to avoid food being affected by any unpleasant odours, we recommend that the oven is dried and the self-cleaning panels are simultaneously regenerated using a fan function at the maximum temperature for approximately 60 minutes.



9. EXTRAORDINARY MAINTENANCE

The oven may require extraordinary maintenance or replacement of parts subject to wear such as gaskets, bulbs, etc. The following instructions describe how to carry out these minor maintenance operations.



Before any intervention that requires access to live parts, disconnect the power supply of the appliance.

9.1 Replacing the light bulb

If a light bulb needs to be replaced because it is worn or burnt out (in multifunction models remove the guide frames; see “8.5.1 Removing guide frames”).

Remove the bulb cover using a tool (e.g. a screwdriver).

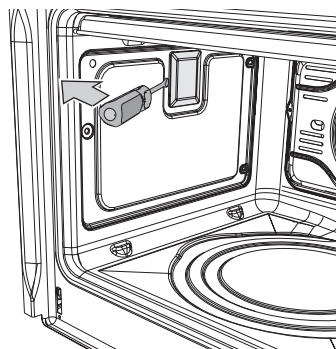

Remove the bulb by sliding it out as shown.

On some models only: the bulbs are halogen bulbs, so **do not touch them directly with your fingers**, wrap them in an insulating material.

Replace the bulb with one of the same type (25W). Replace the cover correctly, so that the moulded part of the glass is facing the door.

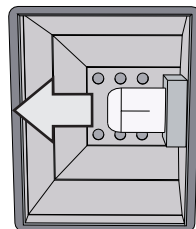

Press the cover down as far as it will go so that it attaches completely to the bulb support.



9.2 Removing the door

9.2.1 With pins

Open the door completely.
Insert two pins into the holes indicated **A** in the two hinges towards the back of them until they engage.

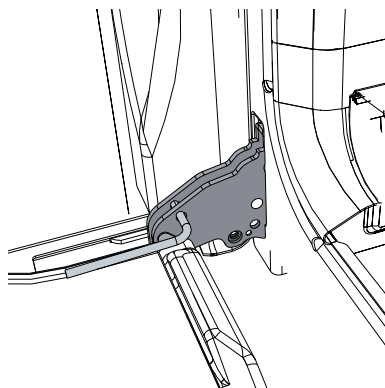

Grasp the door on both sides with both hands, lift it forming an angle of around 30° and remove it.

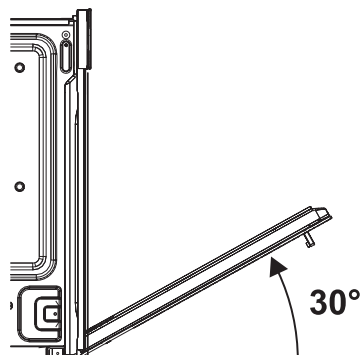

To reassemble the door, put the hinges in the relevant slots in the oven, making sure that grooved sections **C** are resting completely in the slots. Lower the door and once it is in place remove the pins from the holes in the hinges.

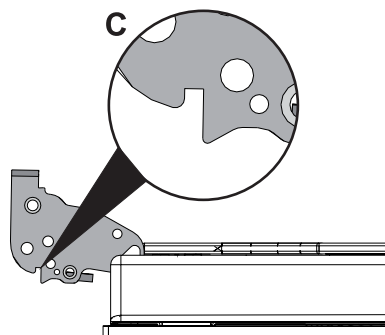



9.3 Removing the door seal

For multifunction models only:

To permit thorough cleaning of the oven, the door seal may be removed.

There are fasteners on all four sides to attach it to the edge of the oven. Pull the edges of the seal outwards to detach the fasteners.

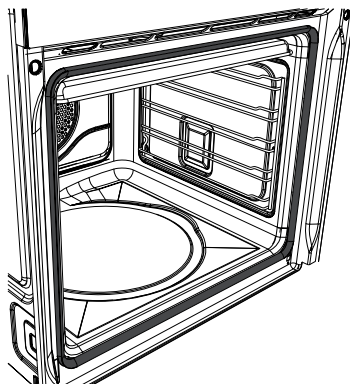

9.4 Removing the internal glass panels

The glass in the door should always be kept thoroughly clean. To facilitate cleaning, it is possible to remove the door (see 9.2 Removing the door) and place it on a canvas, or open it and lock the hinges in order to extract the glass panels.

The glass panels of the door can be completely removed by following the instructions provided below.



Warning: before removing the glass panels, make sure that at least one of the door's hinges has been locked in the open position as described in "9.2 Removing the door". This operation may have to be repeated during the glass removal process if the door is accidentally freed.



1

Removing the internal glass panel:

- Remove the internal glass panel by pulling it upwards, following the movement indicated by the arrows. Doing this detaches the 4 pins attached to the glass from their slots in the oven door.

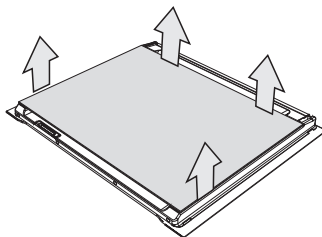

2

**Removing the middle glass panels:
(pyrolytic models)**

- There are two middle glass panels in pyrolytic models, attached using 4 small locks. Remove the middle panes by lifting them upwards.

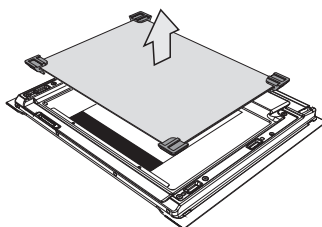
**(Multifunction models)**

- Multifunction models have a single middle panel. Remove the intermediate panel by lifting it upwards.

3

Cleaning:

- It is now possible to clean the external glass panel and the panels removed previously. Use absorbent kitchen roll. In the case of stubborn dirt, wash with a damp sponge and neutral detergent.

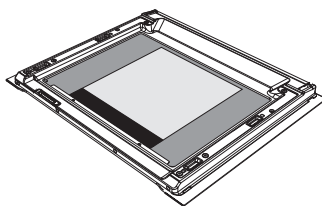

4

Replacing the glass panels:

- Replace the panels in the reverse of the order in which they were removed.
- Reposition the internal glass panel, taking care to centre and insert the 4 pins attached to the glass into their slots in the oven door by applying slight pressure.

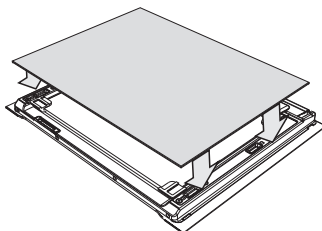



10. INSTALLING THE APPLIANCE

10.1 Electrical connection



The identification plate bearing the technical data, serial number and brand name is visibly positioned on the appliance.

Do not remove this plate for any reason.



The appliance must be connected to earth in compliance with electrical system safety regulations.



If a fixed connection is being used, fit the power line with an omnipolar circuit-breaker in accordance with the installation rules, located in a position which is easy to reach and near the appliance.



If a plug and socket connection is being used, make sure that the plug and socket are compatible. Avoid use of adapters and shunts as these could cause overheating and a risk of burns.

Operation at 220-240 V~: use a H05V2V2-F type **220-240V~** three-core cable (3 x 1.5 mm²).

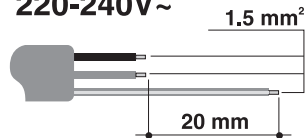

The end to be connected to the appliance must have an earth wire (yellow-green) at least 20 mm longer than the others.



WARNING: The values indicated above refer to the cross-section of the internal conductor.



10.2 Cable replacement

Should the supply cable need replacing, remove the back guard by unscrewing the screws to gain access to the terminal.

Replace the cable. The cable cross-section must be no less than 1.5 mm² (3 x 1.5) (see 10.1 Electrical connection).

Make sure that the cables (for the oven or any hob) follow the best route in order to avoid any contact with the oven.

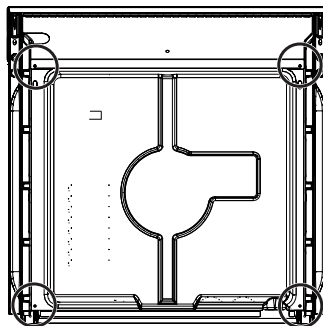

WARNING: The tightening torque of the screws of the terminal supply wires must be **1.5 - 2 Nm**.

10.3 Positioning the oven



Never use the oven door to lever the oven into place when fitting. Avoid exerting too much pressure on the oven door when open.



We recommend installing the oven with the help of a second person.



The base on which the oven is resting must be complete as shown in the illustrations below.

The oven is designed for mounting into any piece of furniture as long as it is heat-resistant (90°C).

Proceed according to the dimensions shown in figures **1**, **2** and **3**.

For installing under a work top, follow the dimensions given in figures **1** and **2**. For installing under a work top with combined cooking hobs, ensure a minimum clearance from any side walls of at least 110 mm.

When installing in tall units, comply with the dimensions shown in figures **1** and **2**, bearing in mind that the top/rear of the unit must have an opening 35-40 mm deep.

Remove the screw covers on the frame and screw in the 2 screws **A** (fig. 5) to fix the appliance to the unit. Replace the screw covers. For installing beneath a countertop hob, allow for a rear and bottom clearance as shown in figure **1** (ref. **F**).

See the relevant instructions for fitting and securing the appliance.



FIG.1

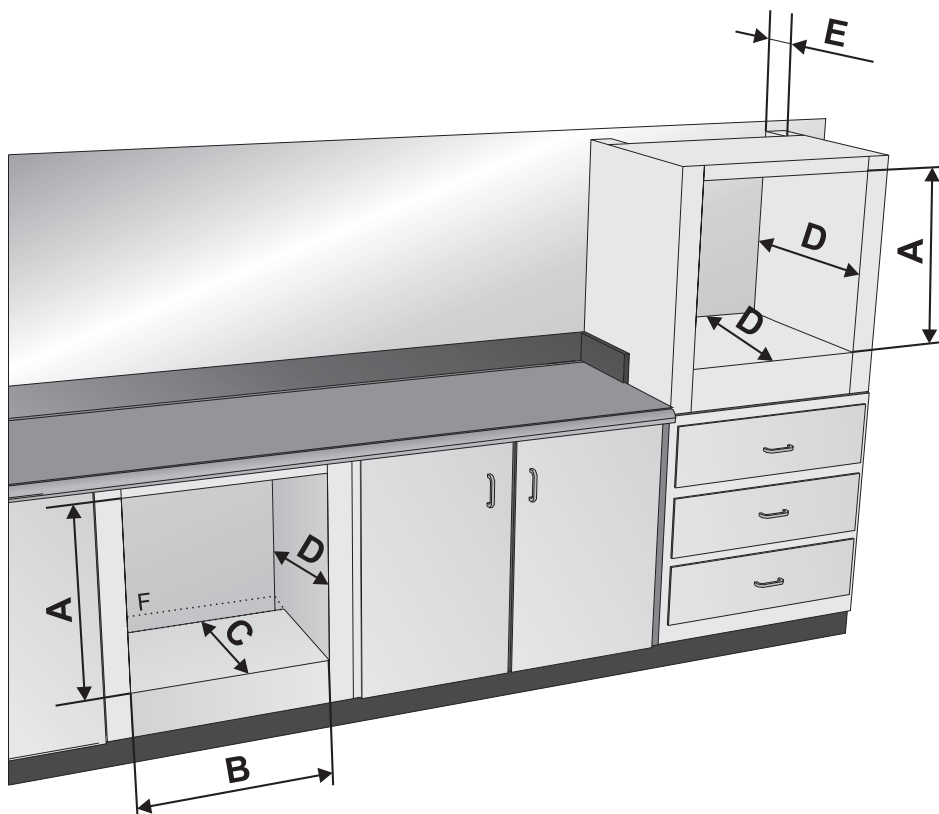

	A	B	C	D	E
Measurements (mm)	583 ÷ 585	554 ÷ 564	490 ÷ 500	560 min.	35 ÷ 40



FIG. 2

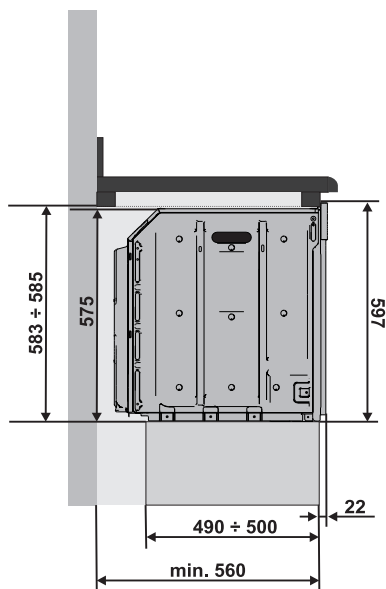

FIG. 3

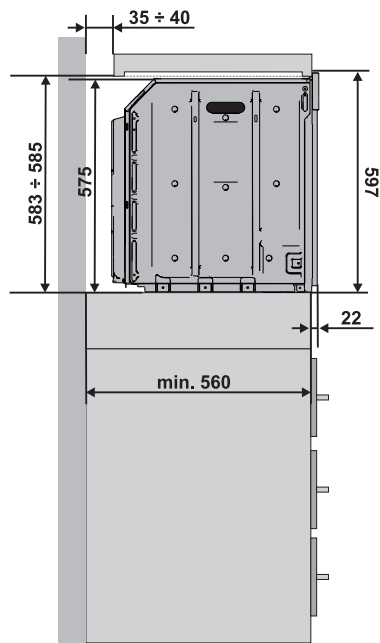

FIG. 4

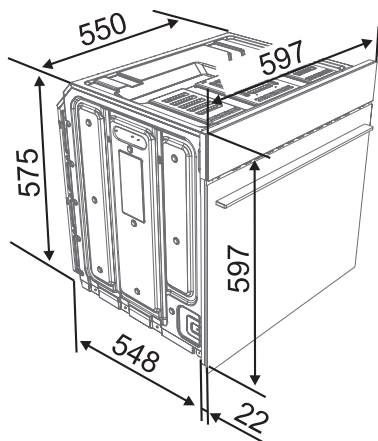

FIG. 5

