

1. INSTRUCTIONS FOR USE .....	54
2. SAFETY PRECAUTIONS .....	56
3. ENVIRONMENTAL CARE.....	58
4. GET TO KNOW YOUR APPLIANCE .....	59
5. AVAILABLE ACCESSORIES .....	62
6. USING THE COOKING HOB.....	66
7. USING THE OVEN .....	69
8. OVEN FUNCTIONS .....	76
9. CLEANING AND MAINTENANCE .....	84
10. EXTRAORDINARY MAINTENANCE .....	90
11. INSTALLING THE APPLIANCE .....	92
12. ADAPTATION TO DIFFERENT TYPES OF GAS.....	100



**INSTRUCTIONS FOR THE USER:** these contain user advice, the description of the controls and the correct procedures for cleaning and maintenance of the appliance.



**INSTRUCTIONS FOR THE INSTALLER:** these are intended for the qualified technician who must install the appliance, set it functioning and carry out an inspection test.



Further information about the products can be found at [www.smeg.com](http://www.smeg.com)



## 1. INSTRUCTIONS FOR USE



This manual is an integral part of the appliance. It must be kept in its entirety and in an accessible place for the whole working life of the appliance. We recommend reading this manual and all information it contains carefully before using the appliance. Installation must be carried out by qualified personnel in accordance with the standards in force. This appliance is intended for domestic use and conforms to the EC directives currently in force. The appliance has been built to carry out the following functions: **cooking and heating up food**; all other uses are considered unsuitable.



These instructions are valid only for the destination countries whose identifying symbols are included on the cover of this manual.



Never obstruct the openings and slots provided for ventilation and heat dispersal; this may cause malfunctions.



Do not use this appliance for heating rooms.



This appliance is marked according to European directive 2002/96/EC on Waste Electrical and Electronic Equipment (WEEE).

This directive defines the standards for the collection and recycling of waste electrical and electronic equipment applicable throughout the European union.



The identification plate with technical data, serial number and brand name is located in an exposed position either in the drawer (where present) or on the back of the appliance. A copy of the identification plate is included in the booklet. It should be applied to the appropriate space on the back of the cover. Do not remove this plate for any reason.



Before the appliance is put into operation, all labels and protective films applied on external surfaces must be removed.



Do not use metallic sponges or sharp scrapers as they will damage the surface. Use normal non-abrasive products and a wooden or plastic tool if necessary. Rinse thoroughly and dry using a soft cloth. Do not allow residues of sugary foods (such as jam) to set inside the oven. If left to set for too long, they might damage the enamel lining of the oven.



Do not use plastic kitchenware or containers. The high temperatures inside the oven could melt the plastic, damaging the appliance.



Always check that the control knobs are in the “zero” (off) position when you finish using the appliance.



## General instructions

GB-IE



Do not use sealed tins or containers in the appliance. Overpressure may occur inside the containers during cooking, creating a danger of explosion.



Do not cover the bottom of the oven with aluminium or tin foil sheets during cooking and do not place pans or trays on it to avoid damage to the enamelled surface.



Never place saucepans with bases which are not perfectly flat and smooth on the hob. Unstable cookware can lead to scalding.



Do not rest any weight or sit on the open door of the appliance. Excessive weight may jeopardise its stability.



The appliance becomes very hot during use. Suitable heat-proof gloves should be worn for all operations.



Do not use the hob if pyrolysis (where present) is taking place inside the oven.



If you intend to go away for a prolonged period of time, close the mains gas tap or the gas cylinder tap.



Take care that no objects are stuck in the door of the oven.



Do not open the storage compartment (where present) when the oven is on and still hot. The temperatures inside it may be very high.



If the surfaces are still very hot during cooking, do not pour water directly onto the trays. The steam could cause severe burns and damage enamelled surfaces.



All cooking operations must take place with the door closed. The dissipation of heat may cause hazards.



**The manufacturer declines all responsibility for damage to persons or things caused by non-observance of the above prescriptions or by interference with any part of the appliance or by the use of non-original spare parts.**



## 2. SAFETY PRECAUTIONS

Consult the installation instructions for safety standards on electrical or gas appliances and for ventilation functions. In your interests and for your safety the law requires that the installation and servicing of all electrical and gas appliances be carried out by qualified personnel in accordance with the standards in force. Our approved installers guarantee a satisfactory job.

Gas or electrical appliances must always be uninstalled by suitably skilled people.



Before connecting the appliance to the power grid, check the data on the plate against the data for the grid itself.



If the appliance is installed on a raised platform, secure it using suitable fastening systems.



Before carrying out installation/maintenance work, make sure that the appliance is disconnected from the power grid.



If cooking appliances are installed in motor vehicles (for example, camper vans, caravans etc.), they must only be used when the vehicle is stationary.



Install the appliance so that when opening the drawers or doors of units positioned at the level of the hob there is no possibility of making contact with pans positioned on top of it.



The plug to be connected to the power supply cable and its socket must be of the same type and conform to the standards in force. The socket must be accessible after the appliance has been installed.

Never disconnect the plug by pulling on the cable.



If the power supply cable is damaged, contact the technical assistance centre immediately and they will replace it.



The appliance must be connected to earth in compliance with electrical system safety standards.



During use the appliance and its accessible parts become very hot. Take care never to touch the heating elements. Keep children younger than 8 away from the appliance, unless under continuous supervision.



Never put inflammable objects in the oven: they could be accidentally ignited and cause fires.



## General instructions

GB-IE



The appliance is intended for use by adults. Do not allow children to go near it or play with it.



This appliance may be used by children from the age of 8 and by people of reduced physical and mental ability or lacking in experience and knowledge, provided they are supervised or instructed on the safe use of the appliance and if they understand the associated risks. Do not allow children to play with the appliance. Do not allow unsupervised children to perform cleaning or maintenance operations.



Never attempt to repair the appliance. All repairs must be carried out by an authorised technician or at an authorised service centre. The improper use of tools can cause hazards.



This appliance must not be controlled using an external timer or remote control system.



Be aware of how rapidly the cooking zones heat up. Do not place empty saucepans on the heat. Danger of overheating.



Fats and oils can catch fire if they overheat. You are therefore recommended not to leave the appliance unattended while preparing foods containing oils or fats. If fats or oils catch fire, never put water on them. Place the lid on the saucepan and turn off the cooking zone.



Take care when using additional electrical appliances in the kitchen (e.g. blender, toaster etc.). Connection cables must not come into contact with hot cooking zones.



Do not use steam jets for cleaning the appliance.  
The steam could reach the electronics, damaging them and causing short-circuits.



Do not spray any spray products near the household appliance while it is in operation. Do not use spray products while the appliance is still hot. The gases contained in spray cans may catch fire.



**The manufacturer declines all responsibility for damage to persons or things caused by non-observance of the above prescriptions or by interference with any part of the appliance or by the use of non-original spare parts.**



### 3. ENVIRONMENTAL CARE

#### 3.1 Our environmental care

---



Pursuant to Directives 2002/95/EC, 2002/96/EC and 2003/108/EC relating to the reduction of the use of hazardous substances in electrical and electronic appliances, as well as to the disposal of refuse, the crossed out bin symbol on the appliance indicates that the product, at the end of its working life, must be collected separately from other refuse. Therefore, the user must consign the product that has reached the end of its working life to the appropriate selective collection centres for electrical and electronic refuse, or deliver it back to the retailer when purchasing an equivalent product, on a one for one basis. Adequate selective collection for the subsequent forwarding of the decommissioned product to recycling, treatment and ecologically compatible disposal contributes to avoiding possible negative effects on the environment and on health and promotes the recycling of the materials of which the appliance consists. Illicit disposal of the product by the user will lead to the application of administrative sanctions.

The product does not contain substances in quantities sufficient to be considered hazardous to health and the environment, in accordance with current European directives.

#### 3.2 Your environmental care

---

Our product's packaging is made of non-polluting materials, therefore compatible with the environment and recyclable. Please help by disposing of the packaging correctly. You can obtain the addresses of collection, recycling and disposal centres from your retailer or from the competent local organisations.



**Do not discard the packaging or any part of it, or leave it unattended. It can constitute a suffocation hazard for children, especially the plastic bags.**

Your old appliance also needs to be disposed of correctly.

**Important:** hand over your appliance to the local agency authorised for the collection of electrical appliances no longer in use. Correct disposal enables intelligent recovery of valuable materials.

Before disposing of your appliance it is important to remove doors and leave shelves in the same position as for use, to ensure that children cannot accidentally become trapped inside during play. It is also necessary to cut the connecting cable to the power grid, removing it along with the plug.



## 4. GET TO KNOW YOUR APPLIANCE

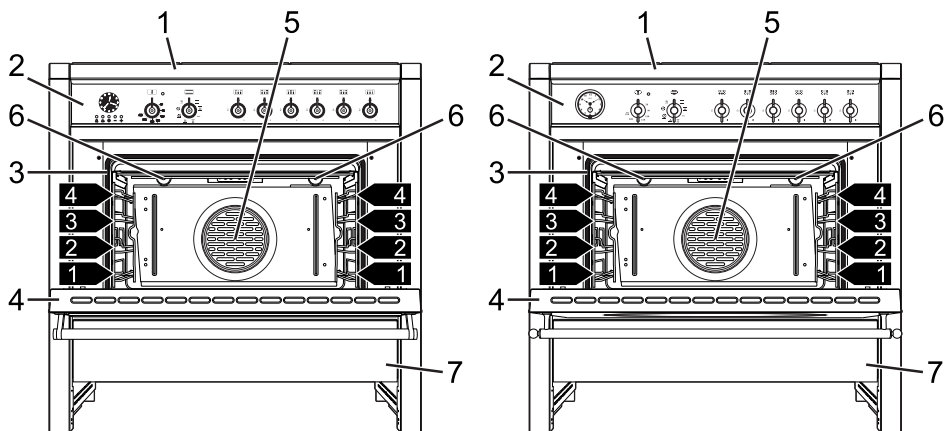

Multifunction models

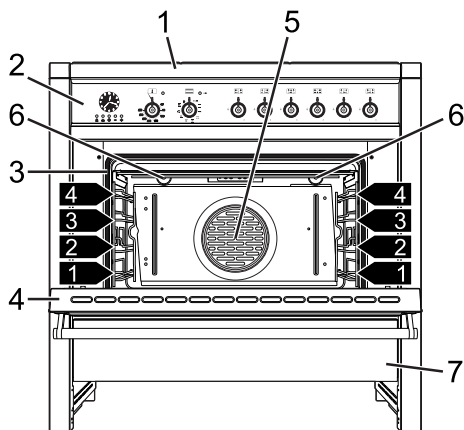

Pyrolytic Model

1 Cooking hob

2 Control panel

3 Oven seal

4 Door

5 Fan

6 Oven light

7 Storage compartment

1,2,3... Frame shelf



## 4.1 Description of the controls on the front panel

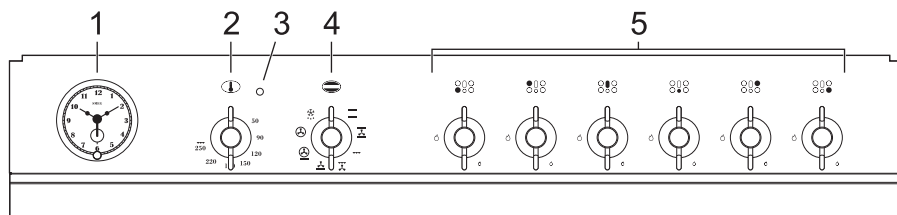
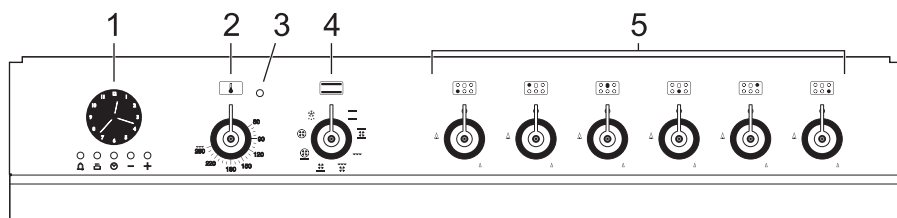

Multifunction models

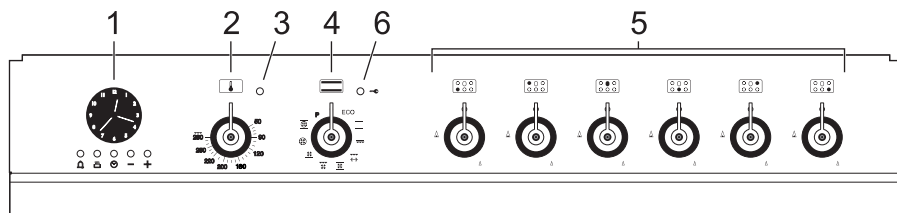

Pyrolytic Model

### 1 Programming clock

The programming clock makes it possible to display the current time or to set a timer or a programmed cooking operation.

### 2 Temperature selection knob

The cooking temperature is selected by turning the knob clockwise to the required setting, between the maximum and the minimum settings.





### 3 Thermostat indicator light

(On multifunction models only)

The indicator light comes on to indicate that the oven is heating up. When this light goes out, the preset heating temperature has been reached. When the light flashes regularly, it means that the temperature inside the oven is kept steady on the set level.





(On pyrolytic models only)

When the indicator light is flashing, it indicates that the oven is heating up to the temperature set using the thermostat knob. Once the oven has reached the selected temperature, the light stops flashing and remains lit steadily until the oven is switched off. Moreover, the light switches on when the automatic cleaning cycle (pyrolysis) starts and remains lit until the cycle is complete.

### 4 Function selection knob

The oven's various functions are suitable for different cooking modes. After selecting the required function, set the cooking temperature using the thermostat knob. For more information on cooking functions, see: "8. OVEN FUNCTIONS".

### 5 Hob burners control knob

To light the flame, press the knob and turn it anti-clockwise to the maximum flame symbol (). To adjust the flame, turn the knob to the zone between the maximum () and the minimum () settings. To turn off the burner, return the knob to the  position.

### 6 Door lock indicator light (on pyrolytic models only)

It switches on when the automatic cleaning cycle (pyrolysis) is activated.



## 5. AVAILABLE ACCESSORIES

**NOTE:** Some models are not provided with all accessories.

**WOK reduction:** useful when using a wok.

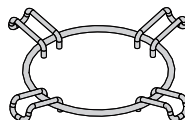

**Wide rack:** useful for holding cooking containers. It can be placed on top of a tray for cooking foods which may drip.

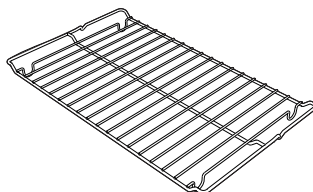

**Narrow rack:** useful for cooking small sized food, such as meat. It can be placed on top of a tray for cooking foods which may drip.

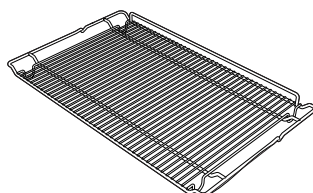

**Tray:** useful for collecting fat from foods placed on the rack above. Necessary when using the rotisserie.

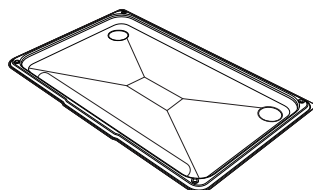

**Rotisserie supports:** They support the rotisserie rod.

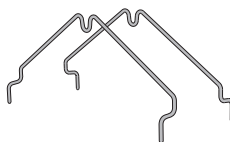

**Rotisserie rod:** for cooking chicken and all foods which require uniform cooking over their entire surface.

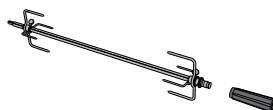



- The oven accessories intended to come into contact with food are made of materials that comply with the provisions of Directive 89/109/EEC, dated 21/12/88, and of Legislative Decree 108, dated 25/01/92.



- Accessories available on request: Original supplied and optional accessories may be ordered from any Authorised Assistance Centre.
- Use only original accessories supplied by the manufacturer.

## 5.1 Using the WOK reduction pan stand

The WOK pan stand should be placed on top of the hob pan stands as shown in the adjacent figure. Make sure they are stable. The WOK pan stand should only be used when cooking with a wok.

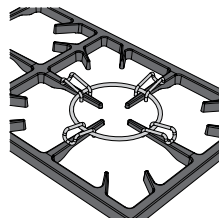

## 5.2 Using the oven racks and trays

The racks and trays are equipped with a mechanical safety lock which prevents them from being taken out accidentally. To insert the rack or tray correctly, check that the lock is facing downwards (as shown in the figure at the side).

To remove the rack or tray, lift the front slightly.

The mechanical lock (or the extension piece where present) must always face the back of the oven.

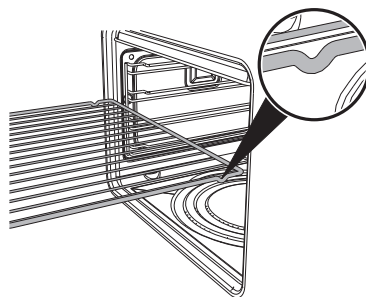

Gently insert racks and trays into the oven until they come to a stop.



### 5.3 Using the rotisserie rod



Keep the oven door closed during cooking.

Use the clip forks provided to prepare the rotisserie rod with the food. The clip forks can be tightened using the fastening screws.

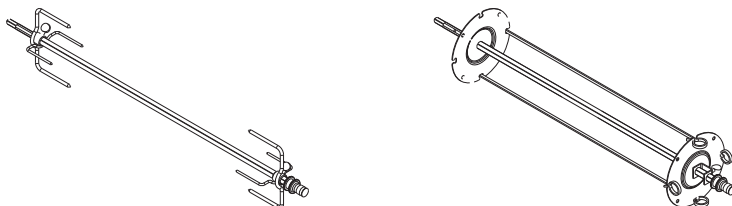

Place the rotisserie supports into the inserts at the corners of the tray. The supports should be placed as shown in the adjacent figure.



Place the rotisserie rod on the supports. Make sure the pins are correctly positioned on the shaped part of the supports.

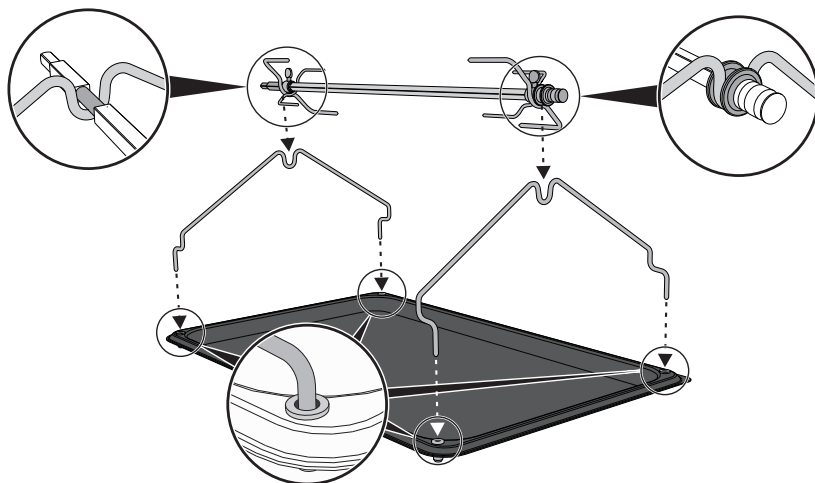



After having prepared the rotisserie rod, place the tray on the first runner (see 4. GET TO KNOW YOUR APPLIANCE).

Rocking the rotisserie supports, insert the tip of the rotisserie rod into the hole of the rotisserie motor on the side of the oven.

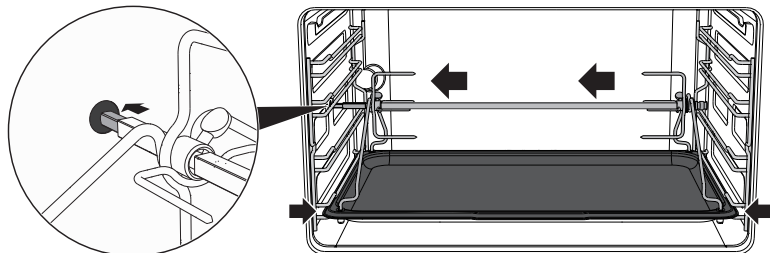

At the end of cooking, screw on the handle provided so that you can move the rod with the food on it readily.



Pour a little water in the drip tray to prevent smoke from forming.



Regular flashing of the thermostat indicator light during cooking is normal and indicates that the temperature inside the oven is being maintained constant.



## 6. USING THE COOKING HOB

### 6.1 General warnings and advice



Before lighting the hob burners, check that the flame-spreader crowns are correctly in place with their respective burner caps, making sure that the holes **1** in the flame-spreaders are aligned with the plugs **3** and thermocouples **2**.

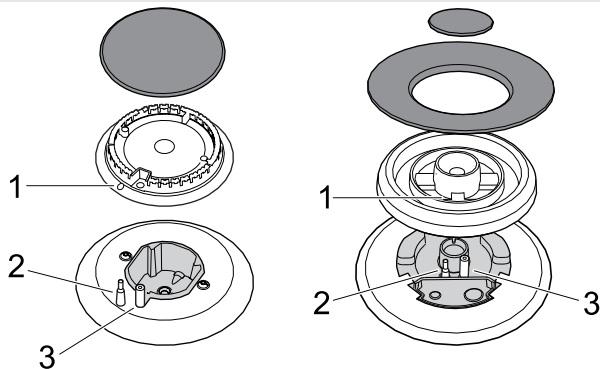

### 6.2 Lighting the hob burners



All the appliance's control and monitoring devices are located together on the front panel. The burner controlled by each knob is shown next to the knob. The appliance is equipped with an electronic lighter. Simply press the knob and turn it anti-clockwise to the maximum flame symbol until the burner lights. If the burner does not light in the first 15 seconds, turn the knob to "0" and wait 60 seconds before trying again. After lighting, keep the knob pressed down for a few seconds to allow the thermocouple to heat up. The burner may go out when the knob is released: in this case, the thermocouple has not heated up sufficiently.

Wait a few moments and repeat the operation, keeping the knob pressed for longer.



If the burners should go out accidentally, a safety device will be tripped, cutting off the gas supply, even if the gas tap is open. In this case, turn the knob to the OFF position and wait at least 60 seconds before trying to light the burner again.



## 6.3 Practical hints for using the hob burners

For better burner efficiency and to minimise gas consumption: use pans with lids and of a suitable size for the burner, so that the flames do not reach up the sides of the pan (see paragraph “6.4 Cookware diameters”). Once the contents come to the boil, turn down the flame far enough to ensure that the liquid does not boil over.

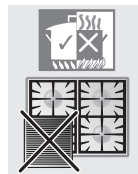

If any liquid does boil over or spill, remove the excess from the hob. To prevent burns or damage to the hob during cooking, all pans or griddles must be placed inside the perimeter of the hob. All pans must have smooth, flat bottoms.

If the flame accidentally goes out, turn off the control knob and wait at least 1 minute before trying to re-light the burner.



Take the greatest care when using fats or oils since they may catch fire if overheated.



#### 6.4 Cookware diameters

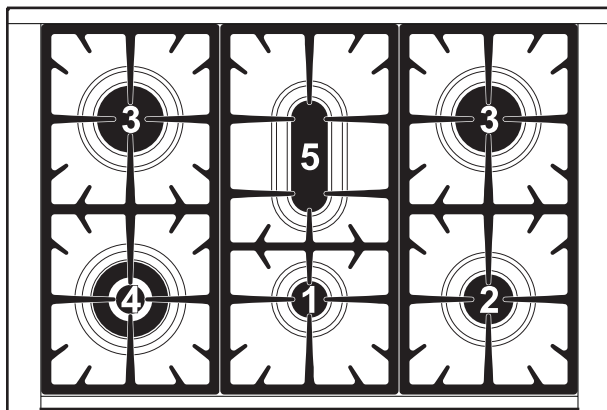

Burner		Ø min. (cm)	Ø max. (cm)
1	Auxiliary	12	14
2	Semi-rapid	16	24
3	Rapid	18	26
4	Ultra-rapid	20	26
5	Fish kettle burner	Suitable oval containers	





## 7. USING THE OVEN

### 7.1 Before using the appliance

---



- Remove any labels (apart from the technical data plate) from trays, dripping pans and the cooking compartment.
- Remove any protective film from the outside or inside of the appliance, including accessories such as trays, dripping pans, the pizza plate or the base cover.
- Before using the appliance for the first time, remove all accessories from the oven compartment and wash them as indicated in “9. CLEANING AND MAINTENANCE”.



**Heat the empty appliance to the maximum temperature** in order to remove any manufacturing residues which could affect the food with unpleasant odours.

### 7.2 Cooling system

---

The appliance is equipped with a cooling system which comes into operation as soon as a cooking function starts. The fan causes a steady outflow of air that exits from the rear of the appliance and which may continue for a brief period of time even after the appliance has been turned off.

### 7.3 Storage compartment

---

The storage compartment is in the bottom of the cooker, underneath the ovens. To open it, pull on the bottom of the door.

It provides storage space for the appliance's metal accessories and must not be used to store flammable materials, cloths, paper etc.



Do not open the storage compartment when the oven is on and still hot. The temperatures inside it may be very high.

### 7.4 Internal oven lights

---

The oven lights switch on by selecting any function.



## 7.5 General warnings and advice for use



**All cooking operations must be carried out with the door closed. The dissipation of heat may cause hazards.**



During cooking, do not cover the bottom of the oven with aluminium or tin foil and do not place pans or oven trays on it as this may damage the enamel coating. If you wish to use greaseproof paper, place it so that it will not interfere with the hot air circulation inside the oven.



For the best cooking results, we recommend placing cookware in the centre of the rack.

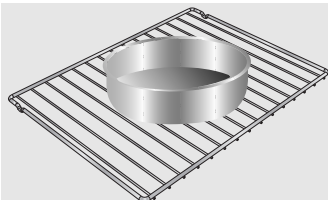

To prevent any steam in the oven from causing problems, open the door in two stages: keep it half open (5 cm approx.) for 4-5 seconds and then open it fully. If you need to access the food, always leave the door open for as short a time as possible to prevent the temperature in the oven from falling and ruining the food.

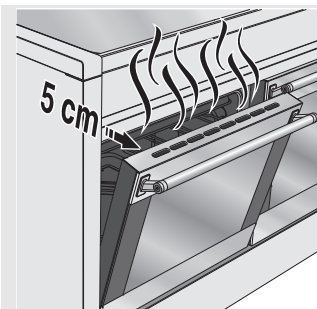

To prevent excessive amounts of condensation from forming on the internal glass, hot food should not be left inside the oven for too long after cooking.



**While cooking desserts or vegetables, excessive condensation may form on the glass. In order to avoid this, open the door very carefully a couple of times while cooking.**



**Heat the empty appliance to the maximum temperature** in order to remove any manufacturing residues which could affect the food with unpleasant odours.



## 7.6 Analogue programmer (on some models only)

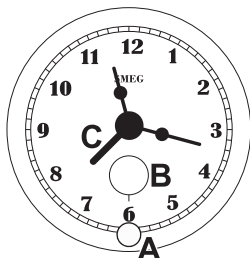

- A Setting knob
- B Cooking symbol window
- C Manual or timed cooking pointer

### 7.6.1 Setting the time

To set the correct time, press inward and turn knob **A** clockwise.



Before each programmer setting, activate the required function and temperature.

### 7.6.2 Timed cooking

Enable the required function and cooking temperature before setting the cooking time. Now, pull out knob **A** and, turning it clockwise, align pointer **C** with the hours pointer. Then, to set the cooking time, visible in window **B**, turn knob **A** clockwise.

### 7.6.3 Cooking start delay

Turn knob **A** clockwise until **0** appears in window **B**. Now, pull out knob **A** and, turning it clockwise, align pointer **C** with the time set for cooking start (the cooking start time cannot exceed 12 hours in relation to the current time). Now, turn knob **A** to symbol  for manual cooking, or to the required cooking time (at the end of the preset time all the oven heating elements will be switched off).

### 7.6.4 Manual cooking

Turn knob **A** clockwise until **0** appears in window **B**. Now, pull out knob **A** and, turning it clockwise, align pointer **C** with the hours pointer.

Then, turn again knob **A** clockwise until symbol  is displayed on window **B**.



## 7.7 Programming clock

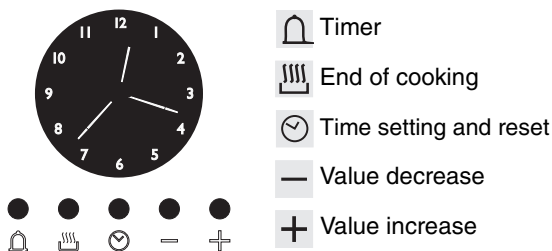





The buzzer that sounds at the end of each programming will be made up of 10 buzzes repeated 3 times at intervals of about 1 minute. It can be stopped at any time by pressing any key.

## 7.8 Analogue clock operation

### 7.8.1 Setting the time





When the oven is used for the first time, or after a power supply failure, the display flashes at regular intervals.

Press the key  to stop the display flashing. Press key  again for 2 seconds; the current time can now be set. Press the value modification keys  or  to increase or decrease the setting by one minute for each pressure. Press either of the value modification keys to display the current time. Five seconds after last pressing the key, the clock will start from the set time.



## 7.8.2 Timer

This function only activates the buzzer, without stopping cooking.

- Press  and the display will light up as shown in figure 1;
- Within 5 seconds press key  or  to set the timer. Each time a key is pressed, an outer segment representing 1 minute of cooking is lit or switched off (figure 2 shows 1 hour and 10 minutes).
- Five seconds after last pressing the key the countdown begins, at the end of which the buzzer activates.
- The current time can be viewed during the countdown by pressing key  once, press the key again to return to the timer display.

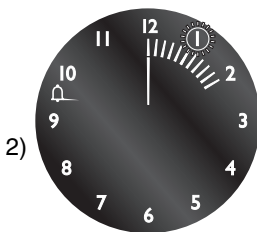
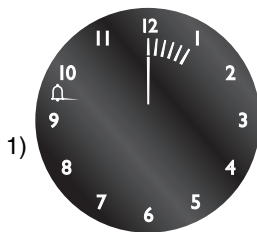









At the end of the countdown the oven must be stopped manually by turning the thermostat knob and the function selector knob to 0.

**it is not possible to set a cooking time of more than 4 hours.**



### 7.8.3 Programming

**Cooking time:** the 2<sup>nd</sup> key  can be pressed to set the cooking time. Before it can be set, the thermostat knob must be turned to the required cooking temperature and the function selector knob to any setting. To set the cooking time, proceed as follows:

- Press key ; the pointer will go to position 12 and the adjacent symbol  will flash (Fig. 1).
- Within 5 seconds press key  or  to set the cooking time: each pressure on  adds 1 minute to the cooking time, and every 12 minutes a new inside segment will light up (figure 2 shows a cooking duration of 1 hour);
- Once the required time is obtained, cooking will start about 5 seconds after the last pressure on  or .
- The display will show the current time, represented by the constantly illuminated segments, and the minutes left to the end of the cooking time, represented by the flashing segments (each flashing segment means 12 minutes of cooking time left).
- At the end of the cooking time the timer will switch the oven heating elements off, the beeps will start to sound and the numbers on the dial will flash.
- The time can also be reset by deleting the program selected: Press the central key  for 2 seconds to cancel the set time and the oven will have to be manually switched off if the cooking operation is in progress.

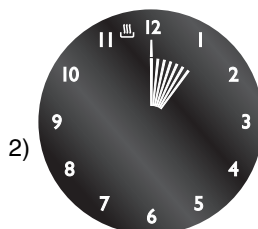
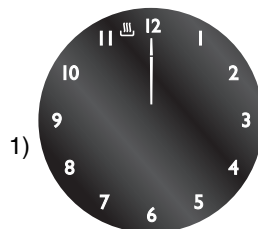

**it is not possible to set a cooking time of more than 12 hours.**



**Cooking start:** as well as setting a cooking time, the cooking start time can also be set (with a maximum delay of 12 hours in relation to the current time). To set the cooking start/end time, proceed as follows:

- Set the cooking time as described in the previous point.
- Within 5 seconds of last pressing key **+** or **-**, press key **||||** again to set the cooking end time. Symbol **⏸** will flash on the display together with the current time, with the internal segments illuminated to show the end of cooking time. Use keys **+** and **-** to set the cooking end time.
- 5 seconds after the last key is pressed, the display will show the current time and the cooking start and end times, which will be represented by the illuminated inside segments. The display segments will be constantly illuminated as long as the current time is not the same as the cooking start time; as soon as the current time reaches the set starting time, all the inside segments will start to flash, indicating that the oven has started cooking.
- At the end of the cooking time the timer will switch the oven heating elements off, the buzzer will start to sound and the numbers on the dial will flash.
- To delete the entire set program, hold down the central key **⌚** for 2 seconds; if cooking has already started, the oven will have to be switched off manually.
- Here we can see a programming example: the current time is 7.06 and cooking is programmed to start at 8.00 and end at 9.00.
- At 8 o'clock the inside segments between 8 and 9 will start to flash, while the hours hand will remain still.



**Warning:** for the oven to start cooking after the programming procedures just described, the thermostat and functions switch knob must be correctly set on the required temperature and function.

## 7.8.4 Display brightness reduction

To reduce energy consumption in stand-by, briefly press key **⌚** to reduce the display brightness. To restore the normal brightness, press **⌚** again.



## 8. OVEN FUNCTIONS



**STATIC:** As the heat comes from above and below at the same time, this system is particularly suitable for certain types of food. Traditional cooking, also known as static or thermal radiation cooking, is suitable for cooking just one dish at a time. Perfect for all types of roasts, bread and cakes and in any case particularly suitable for fatty meats such as goose and duck.

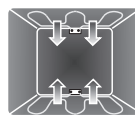

**FAN-ASSISTED STATIC:** The operation of the fan, combined with traditional cooking, ensures uniform cooking even with complex recipes. Perfect for biscuits and cakes, even when simultaneously cooked on several levels.



**GRILL:** Using only the heat released from the central element, this function allows to grill small portions of meat and fish for making kebabs, toasted sandwiches and any type of grilled vegetable side dishes.

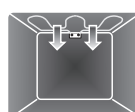

**FAN-ASSISTED GRILL:** The air produced by the fan softens the strong heatwave generated by the grill, giving perfect grilling results even with very thick foods. Perfect for large cuts of meat (e.g. shin of pork).



**FAN-ASSISTED BOTTOM:** The combination of the fan with just the bottom heating element allows cooking to be completed more rapidly. This system is recommended for finishing off the cooking of foods which are already well-cooked on the surface, but not inside, which therefore need a little more heat. Perfect for any type of food.



**BOTTOM + FAN-ASSISTED CIRCULAR:** Fan-assisted cooking is combined with the heat coming from the bottom and allows at the same time to slightly brown food. Perfect for any type of food.



**CIRCULAR:** The combination of the fan and the circular element (incorporated in the rear of the oven) enables different foods to be cooked on several levels, as long as they need the same temperature and same type of cooking operation. Hot air circulation ensures instant and uniform distribution of heat. It will be possible, for instance, to cook fish, vegetables and biscuits simultaneously (on different levels) without mixing odours and flavours.

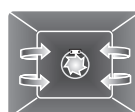





**DEFROSTING:** Rapid defrosting is helped by switching on the fan to ensure uniform distribution of room temperature air inside the oven.

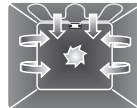

**ECO**

**ECO:** indicates which function gives the least energy consumption. Using the grill and the bottom heating element plus the fan is particularly suitable for heating up food, as it provides low energy consumption.



**WIDE GRILL:** The heat coming from the grill element gives perfect grilling results, especially for thin and medium thickness meat and, in combination with the rotisserie (when present), it allows the food to be browned evenly at the end of cooking. Perfect for sausages, ribs and bacon. This function enables large quantities of food, particularly meat, to be grilled evenly.

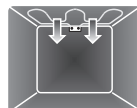

**ROTISSERIE GRILL:** The rotisserie works in combination with the grill element allowing to perfectly brown food.

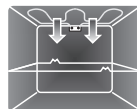

**TURBO:** The combination of fan-assisted cooking and traditional cooking enables different foods to be cooked on several levels extremely quickly and efficiently, without any transfer of odours and flavours. Perfect for large volumes that call for intense cooking.



**P**

**PYROLYSIS:** When this function is set, the oven reaches temperatures of up to 500°C, destroying all the grease which forms on the internal walls.



## 8.1 Cooking advice and instructions

---

### 8.1.1 General advice

**We recommend preheating the oven before putting food in.**

- For cooking on several levels, we recommend using a fan-assisted function to achieve uniform cooking at all heights.
- In general, it is not possible to shorten cooking times by increasing the temperature (the food could be well-cooked on the outside and undercooked on the inside).
- While cooking desserts or vegetables, excessive condensation may form on the glass. In order to avoid this, open the door very carefully a couple of times while cooking.

### 8.1.2 Advice for cooking meat

- Cooking times, especially for meat, vary according to the thickness and quality of the food and to consumer taste.
- We recommend using a meat thermometer for meat when roasting it. Alternatively, simply press on the roast with a spoon: if it is hard, it is ready; if not, it needs another few minutes cooking.

### 8.1.3 Advice for cooking desserts and biscuits

- Use dark metal moulds for desserts: they help to absorb the heat better.
- The temperature and the cooking duration depend on the quality and consistency of the dough.
- Check whether the dessert is cooked right through: at the end of the cooking time, put a toothpick into the highest point of the dessert. If the dough does not stick to the toothpick, the dessert is cooked.
- If the dessert collapses when it comes out of the oven, on the next occasion reduce the set temperature by about 10°C, selecting a longer cooking time if necessary.

### 8.1.4 Advice for defrosting and proving

- We recommend positioning frozen foods in a lidless container on the first shelf of the oven.
- The food must be defrosted without its wrapping.
- Lay out the foodstuffs to be defrosted evenly, not overlapping.
- When defrosting meat, we recommend using a rack positioned on the second runner with the food on it and a tray positioned on the first runner. In this way, the liquid from the defrosting food drains away from the food.
- The most delicate parts can be covered with aluminium foil.
- For successful proving, a container of water should be placed in the bottom of the oven.



## 8.1.5 Advice for cooking with the Grill and the Fan-assisted grill

- Using the Grill function (where present), meat can be grilled even when it is put into the cold oven; preheating is recommended if you wish to change the effect of the cooking.
- With the Fan-assisted grill function (where present), however, we recommend that you preheat the oven before grilling.
- We recommend placing the food at the centre of the rack.

## 8.2 To save energy















---

To save energy while using the appliance, the following instructions may be followed:

- Stop cooking a few minutes before the time normally used. Cooking will continue for the remaining minutes with the heat which has accumulated inside the oven.
- Reduce any opening of the door to a minimum to avoid heat dispersal.
- Use the ECO function (where present) for cooking on a single runner.
- Keep the inside of the appliance clean at all times.





















## 8.3 Cooking tables

TYPES OF FOOD	WEIGHT	FUNCTION
<b>FIRST COURSES</b>		
LASAGNE	3-4 kg	 Static
OVEN-BAKED PASTA	2 kg	 Static
<b>MEAT</b>		
ROAST VEAL	1.2 kg	 Fan-assisted static
PORK LOIN	1.2 kg	 Fan-assisted static
PORK SHOULDER	1.2 kg	 Turbo
ROAST RABBIT	1.2 kg	 Circular
TURKEY BREAST	1.5 kg	 Fan-assisted static
ROAST PORK NECK	2 kg	 Turbo
ROAST CHICKEN	1.2 kg	 Turbo
<b>GRILLED MEATS</b>		
PORK SAUSAGES	1.2 kg	 Fan-assisted grill
PORK CHOPS	1.2 kg	 Grill
HAMBURGERS	0.8 kg	 Grill
BACON	0.8 kg	 Fan-assisted grill
ROTISSERIE CHICKEN	1-1.2 kg	 Rotisserie grill
<b>FISH</b>		
SALMON TROUT	1.2 Kg	 Fan-assisted bottom



RUNNER POSITION FROM BOTTOM	TEMPERATURE °C	TIME IN MINUTES	
1	220 - 230	50 - 60	
1	220 - 230	40	
2	180 - 190	70 - 80	
2	180 - 190	70 - 80	
2	180 - 190	90 - 100	
2	180 - 190	70 - 80	
2	180 - 190	80 - 90	
2	180 - 190	190 - 210	
2	180 - 190	60 - 70	
		1 <sup>ST</sup> SURFACE	2 <sup>ND</sup> SURFACE
3	250 - 280	7 - 9	5 - 6
4	250 - 280	15	5
4	250 - 280	9	5
3	250 - 280	13	3
	250 - 280	70 - 80	
2	150 - 160	35 - 40	



TYPES OF FOOD	WEIGHT	FUNCTION
<b>PIZZA</b>	1 kg	 Pizza
<b>BREAD</b>	1 kg	 Circular
<b>FOCACCIA</b>	1 kg	 Turbo
<b>DESSERTS</b>		
RING CAKE	1 kg	 Fan-assisted static
FRUIT TART	1 kg	 Fan-assisted static
SHORT PASTRY	0.5 kg	 Fan-assisted bottom
JAM TARTS	1.2 kg	 Turbo
PARADISE CAKE	1.2 kg	 Fan-assisted static
CREAM PUFFS	0.8 kg	 Turbo
LIGHT SPONGE CAKE	0.8 kg	 Circular
RICE PUDDING	1 kg	 Turbo
BRIOCHES	0.6 kg	 Circular
BRIOCHES (on multiple runners)		  
SHORT PASTRY BISCUITS (on multiple runners)		  

The times indicated in the following tables do not include the preheating times and are provided as a guide only.



RUNNER POSITION FROM BOTTOM	TEMPERATURE °C	TIME IN MINUTES
1	250 - 280	6 - 10
2	190 - 200	25 - 30
2	180 - 190	15 - 20
2	160	50 - 60
2	160	30 - 35
2	160 - 170	20 - 25
2	160	20 - 25
2	160	55 - 60
2	150 - 160	40 - 50
2	150 - 160	45 - 50
2	160	40 - 50
2	160	25 - 30
1 and 3	160 - 170	16 - 20
1 and 3	160 - 170	16 - 20



For cooking on multiple runners, we recommend that you use functions



, and only, and the 1<sup>st</sup> and 3<sup>rd</sup> runners.



## 9. CLEANING AND MAINTENANCE



Do not use steam jets to clean the appliance. The steam could reach the electronics, damaging them and causing short-circuits.



**WARNING:** For your safety, you are advised to wear protective gloves while performing any cleaning or extraordinary maintenance.



Do not use cleaning products containing chlorine, ammonia or bleach on steel parts or parts with metallic finishes on the surface (e.g. anodizing, nickel- or chromium-plating).



We recommend the use of cleaning products distributed by the manufacturer.

### 9.1 Cleaning the surfaces

To keep the oven surfaces in good condition, they should be cleaned regularly after use. Let the appliance cool first.

### 9.2 Ordinary daily cleaning

To clean and preserve stainless steel surfaces, always use only specific products that do not contain abrasives or chlorine-based acids.

**How to use:** pour the product onto a damp cloth and wipe the surface, rinse thoroughly and dry with a soft cloth or a microfibre cloth.

### 9.3 Food stains or residues

Do not use metallic sponges or sharp scrapers as they will damage the surfaces.

Use normal non-abrasive products and a wooden or plastic tool if necessary. Rinse thoroughly and dry with a soft cloth or a microfibre cloth.

Do not allow residues of sugary foods (such as jam) to set inside the oven. If left to set for too long, they might damage the enamel lining of the oven.







## 9.4 Cleaning the cooking hob parts

### 9.4.1 Pan stands

Remove the pan stands and clean them with lukewarm water and non-abrasive detergent, making sure to remove any encrustations. Dry them thoroughly and return them to the hob.

Continuous contact between the pan stands and the flame can cause modifications to the enamel over time in those parts exposed to heat. This is a completely natural phenomenon which has no effect on the operation of this component.



Do not wash these parts in a dishwasher.

### 9.4.2 Burner caps and flame-spreader crowns

The burner caps and flame-spreader crowns can be removed for easier cleaning. Wash them in warm water and non-abrasive detergent making sure to remove any encrustation, then wait until they are perfectly dry.

Replace the flame-spreader crowns, making sure that they are correctly in place with their respective burner caps and ensuring that the holes A in the flame-spreaders are aligned with the igniters and thermocouples.

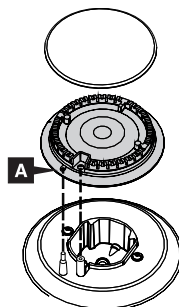

Do not wash these parts in a dishwasher.

### 9.4.3 Igniters and thermocouples

For correct operation, the igniters and thermocouples must always be perfectly clean. Check them frequently and clean them with a damp cloth if necessary. Remove any dry residues with a wooden toothpick or a needle.

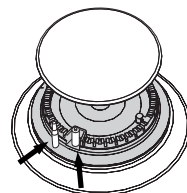

Do not use cleaning products containing chlorine, ammonia or bleach on steel parts or parts with metallic finishes on the surface (e.g. anodizing, nickel- or chromium-plating).



## 9.5 Cleaning the oven



For the best oven upkeep, clean it regularly after having allowed it to cool. Take out all removable parts.

- Clean the oven racks with warm water and non-abrasive detergent. Rinse and dry.
- For easier cleaning, the door can be removed (see “10.2 Removing the door”).



The oven should be operated at the maximum heat setting for 15/20 minutes after use of specific products, to burn off the residues left inside the oven.



When the operation is complete, damp parts should be dried thoroughly.

### 9.5.1 Removing guide frames

Removing the guide frames enables the sides to be cleaned more easily.

To remove the guide frames:

- 1 Pull the frame towards the top of the oven to unhook it from its housing **A**, then slide it out of the seats **B** at the back.
- 2 When cleaning is complete, repeat the above procedures to put the guide frames back in.

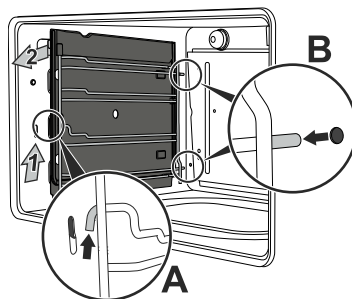

## 9.6 Cleaning the door glazing

The glass in the door should always be kept thoroughly clean. Use absorbent kitchen roll; remove stubborn dirt with a damp sponge and an ordinary detergent.



Do not use abrasive or corrosive detergents to clean the oven door glass panels (e.g. powder products, spot-removers and wire sponges). Do not use rough or abrasive materials or sharp metal scrapers to clean the oven's glass doors since they may scratch the surface.



## 9.7 Removing the door seal (not on pyrolitic models)

To permit thorough cleaning of the oven, the door seal may be removed.

There are fasteners on all four sides to attach it to the edge of the oven. Pull the edges of the seal outwards to detach the fasteners. The seal must be replaced when it loses elasticity and hardens.

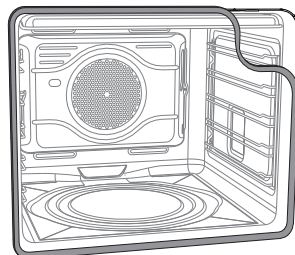

## 9.8 Cleaning the door seal

To keep the seal clean, use a non-abrasive sponge and lukewarm water. The seal should be soft and flexible (with the exception of pyrolitic models).

In pyrolitic models, the seal may flatten over time and lose its original shape. To restore it, pinch the seal all the way along its perimeter. This also helps remove any dirt on the seal.

## 9.9 Cleaning self-cleaning panels (catalysis cycle)

If the self-cleaning panels are dirty, primarily with **small amounts** of grease, a heating cycle can be executed to regenerate them.

Clean the base and the roof liner first with a microfibre cloth soaked in water and neutral washing up liquid, then rinse thoroughly.

Set a regeneration cycle by selecting a fan-assisted function at the maximum temperature for one hour.

If the panels are **particularly dirty**, after the regeneration cycle, remove them and wash them with neutral washing up liquid. Then rinse and dry them.

Put the panels back in the oven and set a fan-assisted function at a temperature of 180°C for one hour, in order to ensure that they are thoroughly dry.



We recommend carrying out the self-cleaning panel regeneration cycle every 15 days.



The panel regeneration cycle is a cleaning method suitable for grease residues, not sugar-based ones.



## 9.10 Pyrolysis: automatic oven cleaning

**P**

Pyrolysis may be carried out at any time of the day or night (if you wish to benefit from the lower cost of electricity overnight).



During the first automatic cleaning cycle, unpleasant odours may occur due to the normal evaporation of oily manufacturing substances. This is an absolutely normal phenomenon which disappears after the first cleaning cycle.



Before starting the automatic cleaning cycle, make sure that the oven does not contain any foods or large spills from previous cooking operations.



During the pyrolysis cycle, a door locking device makes it impossible to open the door.

### 9.10.1 Before starting the automatic cleaning cycle

Pyrolysis may be carried out at any time of the day or night (if you wish to benefit from the lower cost of electricity overnight).

- Completely remove all accessories from inside the oven.
- Remove the guide frames, see “9.5.1 Removing guide frames”.



**In order not to damage the internal glass panel**, it should be cleaned in accordance with the usual procedure before starting the automatic cleaning cycle.

For very stubborn encrustations spray an oven cleaning product onto the glass (read the warnings on the product); leave for 60 minutes, then rinse and dry the glass using kitchen roll or a microfiber cloth.

- Remove the guide frames, see “9.5.1 Removing guide frames”.
- At the end of the cleaning cycle, when the oven has cooled down, reinsert the frames by repeating the previously used procedure in reverse order.
- Make sure that the oven door is firmly closed.



Refer to the following diagram for setting the cleaning cycle duration:

CLEANING DURATION	LIGHT DIRT	MEDIUM DIRT	HEAVY DIRT
	120 MIN.	165 MIN.	210 MIN.



During the automatic cleaning cycle, the fans produce a more intense level of noise due to a greater rotation speed; this is entirely normal and intended to facilitate heat dissipation.

At the end of pyrolysis, the fans will continue to operate for long enough to avoid overheating the walls of adjacent units and the front of the oven.

### 9.10.2 Setting the cleaning cycle

Turn the function selection knob to **P** to select the cleaning cycle.

Press and hold down key ; press keys **-** or **+** to set the cycle duration.

The setting varies between a minimum of 1h 30m and a maximum of 3h 00m.

Two minutes after the cleaning cycle (Pyrolysis) starts, a door locking device will be tripped, preventing the door from being opened. The appropriate light will switch on to indicate that the locking device has been activated.



At the end of the cleaning cycle the door locking device will remain active until the temperature inside the oven has reached a safety threshold. When the oven has cooled down, collect the residues from automatic cleaning with a damp microfibre cloth.

To select a cleaning cycle with a delayed start, after setting the duration press . The time when the cleaning cycle will terminate will appear on the display.

Press and hold down key , and press keys **-** or **+** to set the time at which you wish to terminate the cleaning cycle.



It is not possible to select any functions once the door locking device has been activated. Wait for to go out.



## 10.EXTRAORDINARY MAINTENANCE

The oven requires periodic minor maintenance or replacement of parts subject to wear, such as gaskets, light bulbs, etc. Specific instructions for each operation of this kind are given below.



Before any intervention that requires access to live parts, disconnect the appliance from the power supply.



If a problem cannot be resolved through ordinary maintenance or in case of other types of fault, contact your local technical support centre.

### 10.1 Replacing the light bulbs

Remove the bulb protector **A** by turning it anticlockwise and replace bulb **B** with a similar one. Re-fit bulb protector **A**.  
Use only oven bulbs (T 300°C).

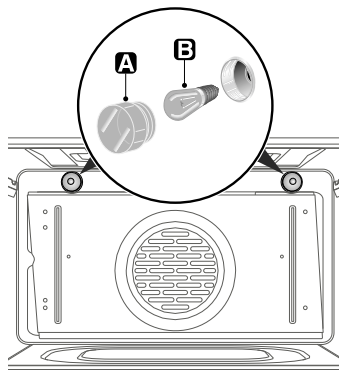



## 10.2 Removing the door

Open the door completely.

Insert two pins into the holes on the hinges towards the back of them until they engage.

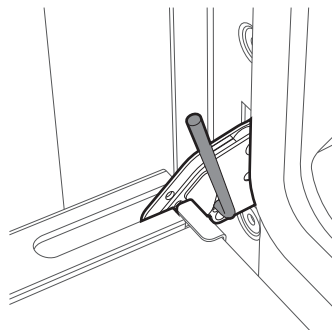

Grasp the door on both sides with both hands, lift it forming an angle of around 30° and remove it.

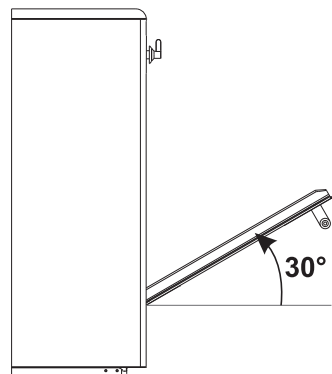

To reassemble the door, put the hinges in the relevant slots in the oven, making sure that grooved sections **C** are resting completely in the slots. Lower the door and once it is in place remove the pins from the holes in the hinges.

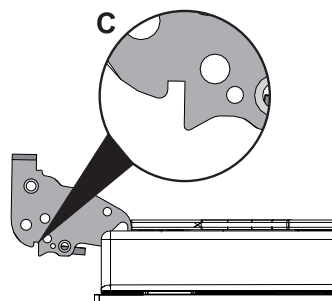



## 11. INSTALLING THE APPLIANCE

### 11.1 Installing in kitchen units



Veneers, adhesives or plastic coatings on adjacent furniture should be temperature-resistant (no less than 90°C). If they are not sufficiently temperature-resistant, they may warp over time.



The appliance must be installed by a qualified technician and according to the regulations in force.

Depending on the type of installation, this appliance belongs to class 2, subclass 1 (Fig. A - Fig. B) or to class 1 (Fig. C).

It may be installed next to walls, one of which must be higher than the worktop, at a minimum distance of 50 mm from the side of the appliance, as shown in figures A and C relative to the installation classes.

Any wall units must be at a minimum distance of at least 750 mm above the appliance. This distance can be reduced to 650 mm if a ventilation hood is installed.

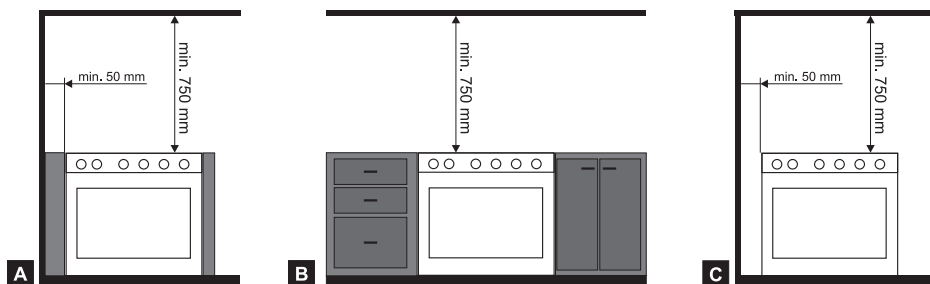

**A** Built-in appliance (Class 2 subclass 1)

**B** Built-in appliance (Class 2 subclass 1)

**C** Free-standing appliance (Class 1)





## 11.2 Room ventilation and combustion extraction



The room containing the appliance should have a permanent air supply in accordance with the standards in force. The room where the appliance is installed must have enough air flow for the regular combustion of gas and for the air exchange needed in the room itself. The air vents, protected by grills, must be suitably dimensioned in compliance with current standards and positioned so that no part of them is obstructed.

The appliance must be kept adequately ventilated in order to eliminate the heat and humidity produced by cooking: in particular, after prolonged use, you are recommended to open a window or to increase the speed of any fans.



Combustion products can be extracted by means of hoods connected to a natural draught chimney whose efficiency is assured or via forced extraction. An efficient extraction system requires precision planning by a specialist qualified in this area and must comply with the positions and distances indicated by the applicable standards. When the job is complete, the installer must issue a certificate of conformity.

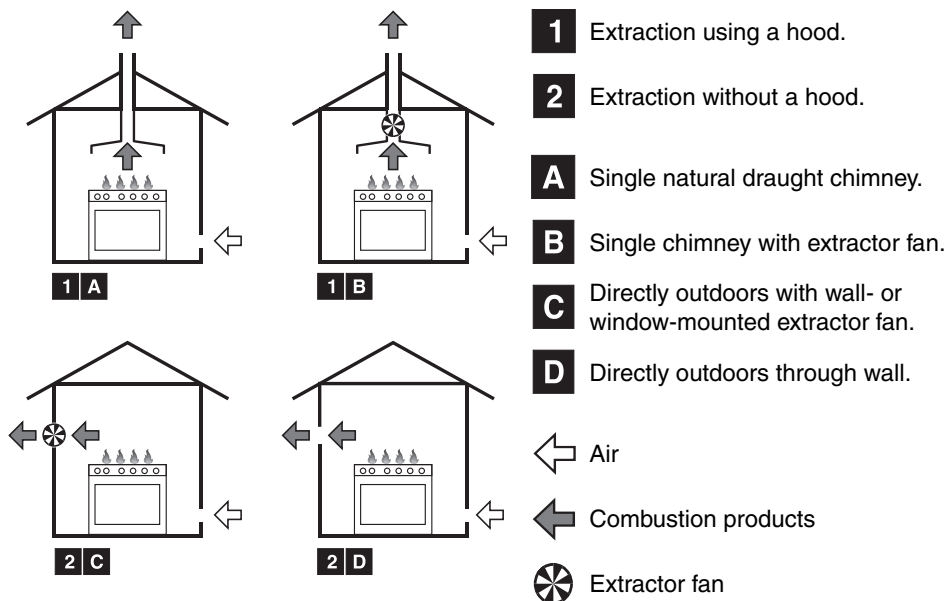



### 11.3 Gas connection



**At the end of the installation, check for any leaks with a soapy solution, never with a flame.**



The tightening torque between connections that incorporate a gasket must be between 10 and 15 Nm.



After carrying out any operation on the appliance, check that the gas connections are properly tightened.



If the appliance is fuelled by LPG, use a standards-compliant pressure regulator and connect to the gas cylinder in accordance with the standards in force.

Make sure that the feed pressure complies with the values indicated in table “12.2 Burner and nozzle characteristics table”.





## 11.3.1 Connection with a rubber hose



**WARNING:** The following instructions are valid solely for Class 1 installations. See fig. C in chapter “11.1 Installing in kitchen units”.



Connection using a rubber hose complying with current standards is only permitted if the hose can be inspected along its entire length.



The inside diameter of the hose must be 8 mm for LPG GAS and 13 mm for NATURAL GAS and CITY GAS.

Installation with a standards-compliant rubber hose must be carried out so that the length of the piping does not exceed 1.5 metres; make sure that the hose does not come into contact with moving parts and that it is not crushed in any way.

Verify that all following conditions are met:

- the hose is fixed to the hose connection with safety clamps;
- no part of the hose is in contact with hot walls (max. 50°C);
- the hose is not under traction or tension and has no kinks or twists;
- the hose is not in contact with sharp objects or sharp corners;
- if the hose is not perfectly airtight and leaks gas, **do not try to repair it**: verify that the hose is not past its expiry date (serigraphed on the hose itself).

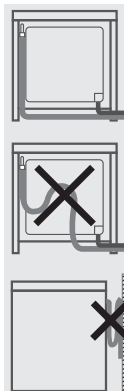

Make the connection to the gas mains using a rubber hose whose specifications comply with current standards (verify that the reference standard is stamped on the hose).

Carefully screw the hose connector **3** to the appliance's gas connector **1** (1/2" thread ISO 228-1), placing the seal **2** between them. The hose connector **4** can also be screwed to the hose connector **3**,

depending on the diameter of the gas hose used. After having tightened the hose connector(s), push the gas hose **6** onto the hose connector and secure it with the clamp **5** that is compliant with the applicable standard.

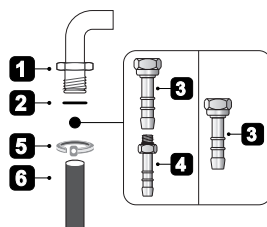



### 11.3.2 Connection with a flexible steel hose



**WARNING:** The following instructions are valid for all types of installation, see fig. A, B, C in chapter “11.1 Installing in kitchen units”.



Only use standards-compliant continuous wall steel hoses no longer than 2 metres.

This type of installation can be used for both built-in and free-standing appliances.

Make the connection to the gas mains using a continuous wall flexible steel hose whose specifications comply with the applicable standard.

Carefully screw the connector **3** to the appliance's gas connector **1** (1/2" thread ISO 228-1), placing the seal **2** between them.

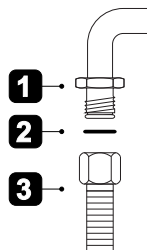

### 11.3.3 Connection with a flexible steel hose with conical fitting (where present)



**WARNING:** The following instructions are valid for all types of installation, see fig. A, B, C in chapter “11.1 Installing in kitchen units”.



Only use standards-compliant continuous wall steel hoses no longer than 2 metres.

This type of installation can be used for both built-in and free-standing appliances.

Make the connection to the gas mains using a continuous wall flexible steel hose whose specifications comply with the applicable standard.

Carefully screw the connector **3** to the appliance's gas connector **1** (1/2" thread ISO 228-1), placing the seal **2** between them. Apply insulating material to the thread of the connector **3**, and then tighten the flexible steel hose **4** to the connector **3**.

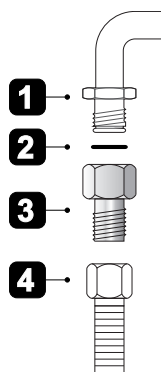



## 11.4 Electrical connection



Make sure the voltage and the cross-section of the power supply line match the specifications indicated on the identification plate positioned on the appliance. Do not remove this plate for any reason. A copy of the plate is attached to the instructions.



The appliance must be connected to the power supply by a qualified technician.



Before performing any operations, switch off the power supply to the appliance.



The appliance must be connected to earth in compliance with electrical system safety standards.



Where the appliance is connected to the power grid via plug and socket, both of these must be of the same type and connected to the power cable in accordance with current standards. The socket must be accessible after the appliance has been built in.

**NEVER UNPLUG BY PULLING ON THE CABLE.**



Should the earthing wire need replacing it must be longer than the conducting wires so that, if the plug is torn off the power cable, it is the last to be detached.



Avoid use of adapters and shunts as these could cause overheating and a risk of burns.



If a fixed connection is being used, fit the power line with an omnipolar circuit breaker with a contact opening gap equal to or greater than **3 mm**, in an easily accessible position close to the appliance.



**The manufacturer declines all responsibility** for damage to persons or things caused by non-observance of the above prescriptions or by interference with any part of the appliance.

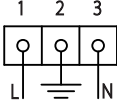
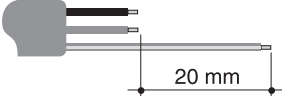

POSSIBLE CONNECTION TYPES	CABLE TYPE (if not present)
<p><b>220 - 240 V 1N~</b></p> 	<p>3-pole      <b>3 x 1.5 mm<sup>2</sup></b>      H05V2V2-F</p> 



- Use H05V2V2-F cables withstanding temperatures of 90°C or higher.
- The values indicated above refer to the cross-section of the internal conductor.
- The tightening torque of the screws of the terminal supply wires must be 1.5 - 2 Nm.

The aforementioned power cables are sized taking into account the coincidence factor (in compliance with standard EN 60335-2-6).

### 11.5 Positioning the skirt



**WARNING: The skirt provided is an integral part of the product; it must be fastened to the appliance prior to installation.**

- Position the skirt above the top, taking care to align holes **A** with holes **B**.
- Secure the skirt to the top by tightening screws **C**.

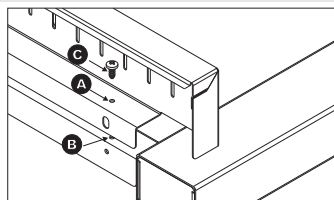

### 11.6 Positioning and levelling the appliance

After making the electrical and/or gas connections, properly level the appliance on the floor to ensure better stability. Screw or unscrew the bottom part of the foot until the appliance is stable and level on the floor.

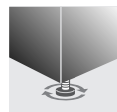



## 11.7 Wall mounting instructions (some markets only)

- 1 Fasten a hook bolt (not supplied) into the wall at a height (**h**) of **800 mm** from the floor.

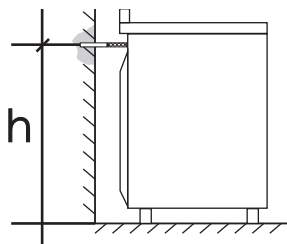

The installer must provide the hook bolt when installing the appliance.

- 2 Attach the snap hook to the chain.
- 3 Attach the end of the chain to the hook bolt fastened in the wall.
- 4 Finally, connect the snap hook to the appropriate hole on the back of the appliance.

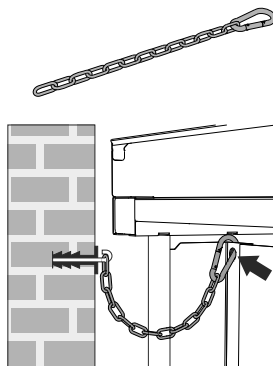



## 12. ADAPTATION TO DIFFERENT TYPES OF GAS



**BEFORE PERFORMING ANY OPERATIONS, SWITCH OFF THE POWER SUPPLY TO THE APPLIANCE.**

Appliance set for gas: **NATURAL GAS G20 (2H) 20 mbar pressure**  
(see label on product)

In case of operation with other types of gas, the burner nozzles must be changed and the minimum flame adjusted on the gas taps.

To change the nozzles, proceed as described in the following paragraphs.

### 12.1 Replacing the hob nozzles

- 1 Remove the pan stands, and remove all burner caps and flame-spreader crowns to access the burner casings.
- 2 Unscrew the nozzles using a 7 mm socket wrench.
- 3 Replace the burner nozzles according to the type of gas to be used (see 12.2 Burner and nozzle characteristics table).
- 4 Replace the burners in the correct position.

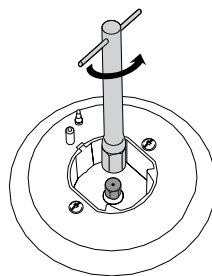
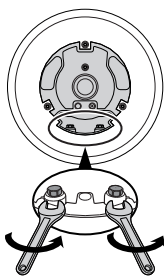





## 12.2 Burner and nozzle characteristics table

For burner arrangement, see “Instructions for the user - 6.4 Cookware diameters”.

Burner	Rated heating capacity (kW)	Natural gas – G20 20 mbar	
		Nozzle diameter 1/100 mm	Reduced capacity (W)
1 Auxiliary	1.05	72	400
2 Semi-rapid	1.8	97	500
3 Rapid	3.0	115	800
4 Ultra-rapid	4.2	135 + 75	1900
5 Fish kettle burner	1.9	94	800

Burner	Rated heating capacity (kW)	LPG – G30/G31 28/37 mbar			
		Nozzle diameter 1/100 mm	Reduced capacity (W)	Capacity g/h G30	Capacity g/h G31
1 Auxiliary	1.05	50	400	76	75
2 Semi-rapid	1.8	65	500	131	129
3 Rapid	3.0	85	800	218	215
4 Ultra-rapid	4.2	91 + 46	1900	305	300
5 Fish kettle burner	1.9	68	800	138	136



## 12.3 Final operations

After replacing the nozzles, reposition the flame-spreader crowns, the burner caps and the pan stands.



Following adjustment to a gas other than the one originally set in the factory, replace the gas setting label fixed to the appliance with the one corresponding to the new gas. The label is inserted inside the nozzle pack (where present).

### 12.3.1 Adjusting the minimum setting for natural and city gas

Light the burner and turn it to the minimum position. Extract the gas tap knob and turn the adjustment screw next to the tap rod (depending on the model) until the correct minimum flame is achieved.

Refit the knob and verify that the burner flame is stable (when turning the knob rapidly from the maximum to the minimum position the flame must not go out). Repeat the operation on all the gas taps.

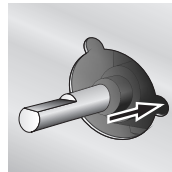
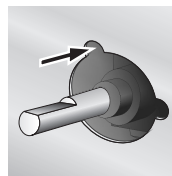

### 12.3.2 Adjusting the minimum setting for LPG

In order to adjust the minimum setting with LPG, the screw at the side of the tap rod must be tightened clockwise all the way.